

PRECISION ROLLING BEARINGS



Precision Rolling Bearings

Table of Contents

Technical Description

1. Bearing Selection	1-1	Bearing Selection Procedure	5
	1-2	Study Bearing Type	6
2. Bearing Life	2-1	Basic Dynamic Load Rating and Rated Life	7
	2-2	Dynamic Equivalent Load	7
	2-3	Angular Contact Ball Bearing Load	8
	2-4	Basic Static Load Rating and Static Equivalent Load	9
3. Bearing Tolerance	3-1	Tolerances for Radial Bearings	10
	3-2	Tolerance for Thrust Load Angular Contact Ball Bearings (T AH/TBH Series)	12
	3-3	Tolerances for Cross Tapered Roller Bearings	12
	3-4	Tolerances for Ball Screw Support Bearing (T AB/T AU series)	13
	3-5	Tolerances for Ball Screw Support Bearings (T AF-X series)	14
	3-6	Tolerances for Tapered Bore Cylindrical Roller Bearings	14
4. Bearing Arrangement	4-1	Features of Bearing Arrangement	15
	4-2	Mounting and Mounting Symbols	16
	4-3	Flush Ground Angular Contact Ball Bearings	16
5. Preload and Rigidity	5-1	Preload Objectives	17
	5-2	Preload Methods	17
	5-3	Measuring Preload	17
	5-4	Preload Effect	18
	5-5	Standard Preload and Axial Rigidity	19
6. Lubrication	6-1	Purpose of Lubrication	27
	6-2	Lubrication Methods	27
7. Limiting Speeds	7-1	Limiting Speed Factors	31
8. Shaft and Housing Design	8-1	Shaft and Housing Fits	32
	8-2	Recommended Accuracy for Shaft and Housing	33
	8-3	Chamfer Dimension Limits	34
9. Bearing Handling	9-1	Storing and Transporting Bearings	35
	9-2	Bearing Installation	35
	9-3	Running Test	39
	9-4	Removing Bearings	39

Dimension Tables

Precision Rolling Bearing Types and Designs		42
	Angular Contact Ball Bearings Standard Type	7900C/7900AC Series 45 7000C/7000AC Series 47 7200C/7200AC Series 49
	High-speed Angular Contact Ball Bearings	BNH Series 53
	Thrust Load Angular Contact Ball Bearings	TAH Series 57 TBH Series 59
	Double row Cylindrical Roller Bearings	NN3000 Series 63 NNU4900 Series 65
	Cross Tapered Roller Bearings	XRN Series 69 XRG Series 69
	Ball Screw Support Bearings	TAB Series 73 TAU Series 77 TAF-X Series 81 XYS1 Series 85 W1 Series 89

Technical Description

Technical Description

Bearing Selection

Bearing Life

Bearing Tolerance

Bearing Arrangement

Preload and Rigidity

Lubrication

Limiting Speeds

Shaft and Housing Design

Bearing Handling

1. Bearing Selection

1-1 Bearing Selection Procedure

While it is not easy to select the optimum bearing type and combination, it is no exaggeration to say that bearing selection is essential in order to obtain the desired design performance and service life. While there is no "best" procedure for selecting the optimal

bearing, the designer should consider giving priority to meeting the most critical requirement of the bearing. Figure 1.1 provides an example of a procedure based on the establishment of priorities for the required bearing characteristics.

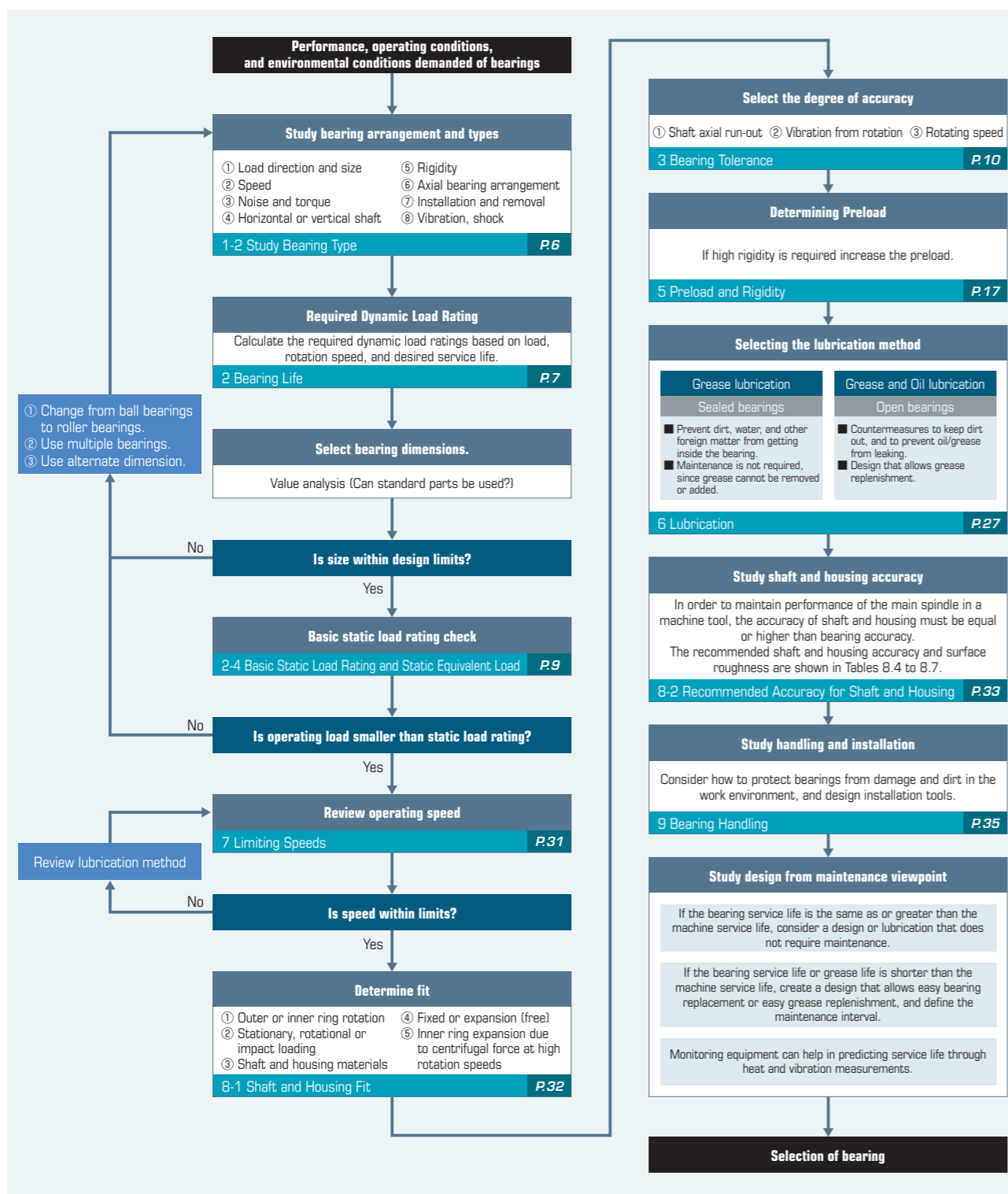

Figure 1.1 Bearing Selection Procedure

1-2 Study Bearing Type

Factors	Selection guidelines
Allowable space for bearings	<ul style="list-style-type: none"> When designing a shaft system, the rigidity and strength of the shaft are important factors. The first step is to determine the shaft diameter, and the bore diameter. Figure 1.2 shows guidelines for the main precision rolling contact bearings types and sizes used in machine tools.
Load (type, direction, magnitude)	<ul style="list-style-type: none"> Select the optimum bearing type in accordance with the magnitude of radial and axial load, direction of the load (either one or both directions), and level (vibration or shock). In general, a roller bearing has a greater load rating capacity than a ball bearing.
Rotating speed	<ul style="list-style-type: none"> Select the bearing type in accordance with the maximum rotating speed specified for the machine where the bearing is used. The limiting speeds of bearings is largely depended on the magnitude of the load applied, running accuracy, cage material, and cage design. Therefore, careful consideration is necessary. In general, angular contact ball bearings or cylindrical roller bearings, which demonstrate minimal temperature rise, are used in high-speed applications.
Rigidity	<ul style="list-style-type: none"> In order to improve the rigidity of rotational axis, the rigidity of the shaft and housing, as well as the bearing rigidity become important. In general, roller bearing rigidity is greater than a ball bearing. The rigidity of combination angular contact ball bearing is increased by applying a preload to the bearing.
Mounting and dismounting	<ul style="list-style-type: none"> Selecting a separable bearing increases work efficiency during mounting and dismounting for periodic inspection, etc.

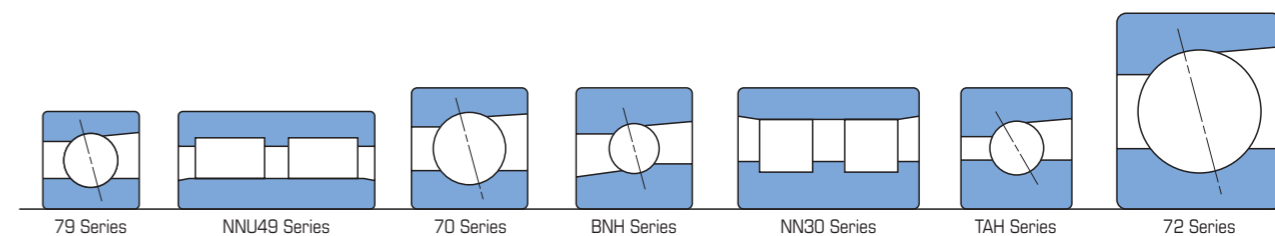

Figure 1.2 Main Precision Rolling Bearings Used in Machine Tools

2. Bearing Life

2-1 Basic Dynamic Load Rating and Rated Life

Although the requirements of rolling contact bearings vary somewhat with the individual application, the principal requirements are:

- High load capabilities
- Low friction
- Smooth and quiet rotation
- High accuracy
- High rigidity

The reliability or durability requirement sets the time frame over which all other requirements are to be maintained. The reliability requirement (life in the broad sense) includes grease and acoustic life, as well as fatigue life. Reliability is reduced by various type of damage and degradation. Though there are other damage such as breakage and seizure, these are considered to be separate from bearing life. Improper handling, mounting, lubrication, and fits are the major causes of problems leading to lower than-calculated bearing life. Regardless of how well they are maintained or mounted or handled, dynamic bearings will eventually fail from rolling fatigue generated by the repetitive stress of bearing load. The service life of a bearing can be examined from two perspectives: 1) If, from inspection, a trace of fatigue becomes noticeable, the bearing should be deemed not suitable for further use; or 2) length of bearing life in hours or revolutions can be predefined as a limit beyond which the bearing is automatically replaced. Since calculated fatigue life will vary with the size and type of bearings used under identical load conditions, great care must be taken in the analysis of the load conditions and the final choice of bearings to satisfy the application requirements. Fatigue lives of individual bearing are dispersed. When a group of identical bearings operates under the same conditions, the statistical phenomenon of dispersion will appear. Use of average life is not an adequate criterion for selecting rolling contact bearings. Instead, it is more appropriate to consider the limit (hours or numbers of revolutions) which a large percentage of the operating bearings can attain. Accordingly, the rating life and basic dynamic load rating Cr or Ca are defined using the following definition

● Basic Rating Life

Total number of revolutions that 90% of a group of identical bearings operated individually under equal conditions can complete without suffering material damage from rolling fatigue.

● Basic Dynamic Load Rating (Cr or Ca)

Bearing load of constant direction and magnitude that ends the bearing life after one million revolutions.

The rating life of bearings is calculated by Formula 2.1 and Formula 2.2.

$$L = \left(\frac{C}{P} \right)^p \quad \text{(Formula 2.1)}$$

$$L_h = \left(\frac{C}{P} \right)^p \cdot \frac{10^6}{60n} \quad \text{(Formula 2.2)}$$

- L : Basic rating life (10⁶ revolutions)
- L_h : Basic rating life (hours)
- C : Basic Dynamic Load Rating (N) (Cr for radial bearings, Ca for thrust bearings)
- P : Bearing Load (Dynamic Equivalent Load) (N) (Pr for radial bearings, Pa for thrust bearings)
- p : 3 (ball bearings), 10/3 (roller bearings)
- n : RPM: (min⁻¹)

In case of multiple row ball bearing combinations, the basic dynamic load rating is calculated using the factors provided below.

2-row arrangement	3-row arrangement	4-row arrangement
1.62	2.16	2.64

2-2 Dynamic Equivalent Load

Bearing load P in Formula 2.1 and Formula 2.2 is the pure radial load (pure axial load) of constant direction and magnitude. Under actual operating conditions, there are many cases where radial and axial loads are applied simultaneously. In such cases, bearing life must be calculated by converting the radial and axial loads into dynamic equivalent load. Dynamic equivalent load is calculated using Formula 2.3. Bearing load of constant direction and magnitude that ends the bearing life after one million revolutions. The rating life of bearings is calculated by Formula 2.1 and Formula 2.2.

$$Pr = XFr + YFa \text{ or } Pa = XFr + YFa \quad \text{(Formula 2.3)}$$

- Pr : Dynamic equivalent radial load (N)
- Pa : Dynamic equivalent axial load (N)
- Fr : Radial load (N)
- Pa : Axial load (N)
- X : Radial load factors (Table 2.1)
- Y : Axial load factors (Table 2.1)

● Table 2.1 Load Factors

	Nominal contact angle	iFa/Cor	e	Single row and DT combination		DB and DF combination			
				Fa/Fr > e		Fa/Fr ≤ e		Fa/Fr > e	
				X	Y	X	Y	X	Y
Radial ball bearings	15°	0.015	0.38	0.44	1.47	1	1.65	0.72	2.39
		0.029	0.40		1.40		1.57		2.28
		0.058	0.43		1.30		1.46		2.11
		0.087	0.46		1.23		1.38		2.00
		0.12	0.47		1.19		1.34		1.93
		0.17	0.50		1.12		1.26		1.82
		0.29	0.55		1.02		1.14		1.66
		0.44	0.56		1.00		1.12		1.63
		0.58	0.56		1.00		1.12		1.63
		25°	-		0.68		0.41		0.87
30°	-	0.80	0.39	0.76	0.78	0.63	1.24		
40°	-	1.14	0.35	0.57	0.55	0.57	0.93		
Thrust ball bearings	50°	-	1.49	0.73	1	1.37	0.57	0.73	1
	55°	-	1.79	0.81	1	1.60	0.56	0.81	1
	60°	-	2.17	0.92	1	1.90	0.55	0.92	1

- (Note 1) i = 2 for DB and DF, i = 1 for single and DT.
- (Note 2) For single and DT, use Pr=Fr when Fa/Fr ≤ e.
- (Note 3) When the nominal contact angle is 15°, use linear interpolation to determine X, Y, and e values of iFa/Cor that are not included in the table.
- (Note 4) For high-speed use (dmn value > 800,000), the centrifugal force of the roller must also be taken into consideration in addition to the external load. Please consult NACHI concerning such applications.

2-3 Angular Contact Ball Bearing Load

In the case of angular contact ball bearings, the points where the extended contact lines within the bearing and the axis as shown in Figure 2.1 must be used as the bearing support points (load centers). Because of this, angular contact ball bearings are shown in dimension tables with "a" dimensions indicating support point positions. This consideration is particularly important when a moment load is acting on a bearing series. Axial component forces are generated when a radial load acts on an angular contact ball bearing. You can calculate the axial component forces using Formula 2.4.

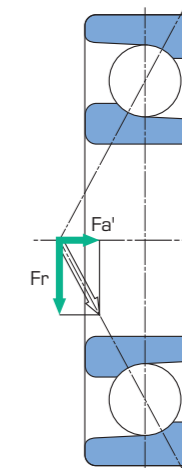

$$Fa' = \frac{Fr}{2Y} \quad \text{(Formula 2.4)}$$

- Fa' : Induced axial load (N)
- Fr : Radial load (N)
- Y : Axial load factor

Due to these component forces, the axial load and dynamic equivalent radial load acting on the bearing is as shown in Table 2.2.

Figure 2.1 Induced Axial Load for Angular Contact Ball Bearings

● Table 2.2 Axial Load and Dynamic Equivalent Load of Angular Contact Ball Bearings

Bearing arrangement	Load conditions	Axial load	Dynamic equivalent radial load
	$Fa \geq 0.5 \left(\frac{Fr_I}{Y_I} - \frac{Fr_{II}}{Y_{II}} \right)$	$Fa_I = Fa_{II} + Fa$ $Fa_{II} = 0.5 \frac{Fr_{II}}{Y_{II}}$	$Pr_I = X_I Fr_I + Y_I (Fa_{II} + Fa)$ $Pr_{II} = Fr_{II}$
	$Fa < 0.5 \left(\frac{Fr_I}{Y_I} - \frac{Fr_{II}}{Y_{II}} \right)$	$Fa_I = 0.5 \frac{Fr_I}{Y_I}$ $Fa_{II} = Fa_I - Fa$	$Pr_I = Fr_I$ $Pr_{II} = X_{II} Fr_{II} + Y_{II} (Fa_I - Fa)$
	$Fa \geq 0.5 \left(\frac{Fr_{II}}{Y_{II}} - \frac{Fr_I}{Y_I} \right)$	$Fa_I = 0.5 \frac{Fr_I}{Y_I}$ $Fa_{II} = Fa_I + Fa$	$Pr_I = Fr_I$ $Pr_{II} = X_{II} Fr_{II} + Y_{II} (Fa_I + Fa)$
	$Fa < 0.5 \left(\frac{Fr_{II}}{Y_{II}} - \frac{Fr_I}{Y_I} \right)$	$Fa_I = Fa_{II} - Fa$ $Fa_{II} = 0.5 \frac{Fr_{II}}{Y_{II}}$	$Pr_I = X_I Fr_I + Y_I (Fa_{II} - Fa)$ $Pr_{II} = Fr_{II}$

- Fr_I, Fr_{II} : Radial load (N) applied to bearings I and II
- Y_I, Y_{II} : Axial load factors of bearings I and II
- Pr_I, Pr_{II} : Dynamic equivalent radial load (N) of bearings I and II
- Fa : External axial load (N)
- X_I, X_{II} : Radial load factors of bearings I and II

2.4 Basic Static Load Rating and Static Equivalent Load

2.4.1 Basic Static Load Rating

Load applied to stationary bearings can create permanent indentions in the load surfaces. While some level of deformation can be tolerated, a level of deformation will be reached where noise and vibration during operation of the bearing, will make the bearing unusable. The term Basic Static Load Rating (C_{or} or C_{oa}) refers to the maximum contact stress value of the static load when the rolling element and raceways contact.

Ball bearings — 4200 MPa

Roller bearings — 4000 MPa

With these contact stresses, the sum of deformations is approximately 1/10,000 of the diameter of the rolling element. (Figure 2.2).

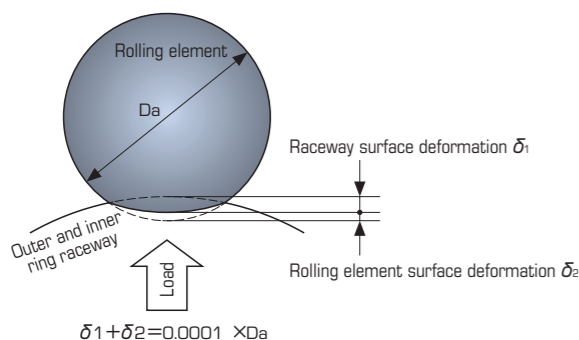

Figure 2.2 Permanent Indentation

2.4.2 Static Equivalent Load

Static equivalent load is the static load that reflects the actual load conditions to the contact section of the rolling elements and raceway receiving the maximum stress.

For radial bearings, radial load of a constant direction and magnitude is called the static equivalent radial load, and for thrust bearings, axial load of a constant direction and magnitude is called the static equivalent axial load.

To calculate the static equivalent radial load, the larger of the two values obtained from Formula 2.5 and Formula 2.6 are to be used.

$$P_{or} = X_o Fr + Y_o Fa \quad \text{(Formula 2.5)}$$

$$P_{or} = Fr \quad \text{(Formula 2.6)}$$

The static equivalent axial load is calculated using Formula 2.7.

$$P_{oa} = X_o Fr + Y_o Fa \quad \text{(Formula 2.7)}$$

- P_{or} : Static equivalent radial load (N)
- P_{oa} : Static equivalent axial load (N)
- Fr : Radial load (N)
- Fa : Axial load (N)
- X_o : Static radial load factors (Table 2.3)
- Y_o : Static axial load factors (Table 2.3)

Table 2.3 Static Load Factors

	Nominal contact angle	Single or DT		DB or DF	
		X _o	Y _o	X _o	Y _o
Radial ball bearings	15°	0.5	0.46	1	0.92
	25°	0.5	0.38	1	0.76
	30°	0.5	0.33	1	0.66
	40°	0.5	0.26	1	0.52
Thrust ball bearings	50°	2.74	1	2.74	1
	55°	3.28	1	3.28	1
	60°	3.98	1	3.98	1

2.4.3 Safety Factors

The basic static load rating is considered as the limiting load for general applications.

An application may require a safety factor larger than 1.

Formula 2.8 and Table 2.4 show the calculation formula and safety factors (guidelines).

$$P_o \max = \frac{C_o}{S_o} \quad \text{(Formula 2.8)}$$

- P_{o max} : Permissible static equivalent load (N)
- C_o : Basic static load rating (N)
- S_o : Safety factors (Table 2.4)

Table 2.4 Safety Factors S_o

Application conditions	S _o	
	Ball bearings	Roller bearings
High rotating accuracy is needed	2	3
Vibration and or impact present	1.5	2
Normal operating conditions	1	1.5

2.4.4 Permissible Thrust Load

A permissible thrust load exists for bearings that can be applied with axial load like an angular contact ball bearings.

For ball bearings, the permissible load is the smaller of the following two values.

- ① Axial load when the contact pressure value between the roller and raceway surfaces is 4200 MPa or less
- ② Axial load causing the contact ellipse formed between the roller and raceway surface to deviate beyond the raceway shoulder (Figure 2.3)

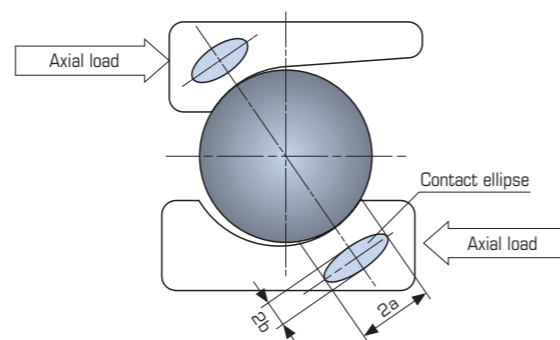

Figure 2.3 Contact Ellipse

3. Bearing Tolerance

3-1 Tolerances for Radial Bearings

The tolerance of rolling contact bearings includes dimensional and running accuracy. The tolerances is classified by ISO 492 and JIS B 1514 (Rolling bearings - Tolerances), with precision rolling bearings conforming to

Class 5, 4, and 2. Tolerances for Radial Bearings are shown in Table 3.1 and Table 3.2 (P.11).

Table 3.1 Tolerances of Inner Ring (JIS Class 5, Class 4, Class 2)

Unit: μm

Nominal bearing bore diameter d (mm)	Single plane mean bore diameter variation Δ_{dmp}						Bore diameter deviation Δ_{ds}				Single plane bore difference V_{dsp}				Single plane mean bore diameter difference V_{dmp}				
	Class 5		Class 4		Class 2		Class 4		Class 2		Class 5		Class 4		Class 5	Class 4	Class 2		
	Over	Incl.	Upper	Lower	Upper	Lower	Upper	Lower	Diameter series				Diameter series				max	max	max
									0,2		9	0,2	9	0,2	max	max			
2.5	10	0	-5	0	-4	0	-2.5	0	-4	0	-2.5	5	4	4	3	3	2	1.5	
10	18	0	-5	0	-4	0	-2.5	0	-4	0	-2.5	5	4	4	3	3	2	1.5	
18	30	0	-6	0	-5	0	-2.5	0	-5	0	-2.5	6	5	5	4	3	2.5	1.5	
30	50	0	-8	0	-6	0	-2.5	0	-6	0	-2.5	8	6	6	5	4	3	1.5	
50	80	0	-9	0	-7	0	-4	0	-7	0	-4	9	7	7	5	5	3.5	2	
80	120	0	-10	0	-8	0	-5	0	-8	0	-5	10	8	8	6	5	4	2.5	
120	150	0	-13	0	-10	0	-7	0	-10	0	-7	13	10	10	8	7	5	3.5	
150	180	0	-13	0	-10	0	-7	0	-10	0	-7	13	10	10	8	7	5	3.5	
180	250	0	-15	0	-12	0	-8	0	-12	0	-8	15	12	12	9	8	6	4	

Unit: μm

Nominal bearing bore diameter d (mm)	Inner ring radial run-out of assembled bearing K_{ia}			Inner ring reference face runout with bore S_d			Assembled bearing inner ring reference face runout with raceway S_{ia}			Deviation of a single ring width Δ_{Bs}						Inner ring width variation V_{Bs}								
	Class 5		Class 4		Class 2		Class 5		Class 4		Class 2		Class 5		Class 4/Class 2		Class 5/Class 4/Class 2		Class 5		Class 4		Class 2	
	Over	Incl.	max	max	max	max	max	max	max	max	max	max	Single bearing				Duplex bearing ⁽³⁾		max	max	max			
													Upper	Lower	Upper	Lower	Upper	Lower						
2.5	10	4	2.5	1.5	7	3	1.5	7	3	1.5	0	-40	0	-40	0	-250	5	2.5	1.5					
10	18	4	2.5	1.5	7	3	1.5	7	3	1.5	0	-80	0	-80	0	-250	5	2.5	1.5					
18	30	4	3	2.5	8	4	1.5	8	4	2.5	0	-120	0	-120	0	-250	5	2.5	1.5					
30	50	5	4	2.5	8	4	1.5	8	4	2.5	0	-120	0	-120	0	-250	5	3	1.5					
50	80	5	4	2.5	8	5	1.5	8	5	2.5	0	-150	0	-150	0	-250	6	4	1.5					
80	120	6	5	2.5	9	5	2.5	9	5	2.5	0	-200	0	-200	0	-380	7	4	2.5					
120	150	8	6	2.5	10	6	2.5	10	7	2.5	0	-250	0	-250	0	-380	8	5	2.5					
150	180	8	6	5	10	6	4	10	7	5	0	-250	0	-250	0	-380	8	5	4					
180	250	10	8	5	11	7	5	13	8	5	0	-300	0	-300	0	-500	10	6	5					

[Note 1] Applies to bearings with cylindrical bore.

[Note 2] Applies to ball bearings.

[Note 3] Applies to the rings of single bearings made for mounted bearings.

Remark: The high deviation of bearing bore diameter of cylindrical bore bearings in Table 3.1 does not apply within a distance from the raceway ring face of 1.2 x r max of the chamfer.

Table 3.1 does not apply within a distance from the raceway ring face of 1.2 x r max of the chamfer.

Bearing Tolerance

● Table 3.2 Tolerances of Outer Ring (JIS Class 5, Class 4, Class 2)

Unit: μm

Nominal bearing outside diameter D (mm)		Single plane mean outside diameter variation of outer ring ΔD_{mp}						Outside diameter deviation ΔD_s				Outside diameter variation in a single radial plane ⁽¹⁾ V_{Dsp}			Mean outside diameter variation V_{Dmp}				
		Class 5		Class 4		Class 2		Class 4		Class 2		Class 5	Class 4		Class 2	Class 5	Class 4	Class 2	
		Over	Incl.	Upper	Lower	Upper	Lower	Upper	Lower	Diameter series			Diameter series			max	max	max	
								0,2			9	0,2	9	0,2	0,2				
								Upper	Lower	Upper	Lower	max	max	max	max	max			
18	30	0	-6	0	-5	0	-4	0	-5	0	-4	6	5	5	4	4	3	2.5	2
30	50	0	-7	0	-6	0	-4	0	-6	0	-4	7	5	6	5	4	4	3	2
50	80	0	-9	0	-7	0	-4	0	-7	0	-4	9	7	7	5	4	5	3.5	2
80	120	0	-10	0	-8	0	-5	0	-8	0	-5	10	8	8	6	5	5	4	2.5
120	150	0	-11	0	-9	0	-5	0	-9	0	-5	11	8	9	7	5	6	5	2.5
150	180	0	-13	0	-10	0	-7	0	-10	0	-7	13	10	10	8	7	7	5	3.5
180	250	0	-15	0	-11	0	-8	0	-11	0	-8	15	11	11	8	8	8	6	4
250	315	0	-18	0	-13	0	-8	0	-13	0	-8	18	14	13	10	8	9	7	4
315	400	0	-20	0	-15	0	-10	0	-15	0	-10	20	15	15	11	10	10	8	5

Nominal bearing outside diameter D (mm)		Outer ring radial runout of assembled bearing K_{ca}			Variation of outside surface generatrix inclination with outer ring reference S_D			Assembled bearing outer ring reference face runout with raceway ⁽²⁾ S_{ca}			Deviation of a single ring width ΔC_s	Outer ring width variation V_{Cs}		
		Class 5	Class 4	Class 2	Class 5	Class 4	Class 2	Class 5	Class 4	Class 2		Class 5	Class 4	Class 2
Over	Incl.	max	max	max	max	max	max	max	max	max		max	max	max
18	30	6	4	2.5	8	4	1.5	8	5	2.5	Corresponds to the values of ΔB_s of the inner ring being matched with it.	5	2.5	1.5
30	50	7	5	2.5	8	4	1.5	8	5	2.5		5	2.5	1.5
50	80	8	5	4	8	4	1.5	10	5	4		6	3	1.5
80	120	10	6	5	9	5	2.5	11	6	5		8	4	2.5
120	150	11	7	5	10	5	2.5	13	7	5		8	5	2.5
150	180	13	8	5	10	5	2.5	14	8	5		8	5	2.5
180	250	15	10	7	11	7	4	15	10	7		10	7	4
250	315	18	11	7	13	8	5	18	10	7		11	7	5
315	400	20	13	8	13	10	7	20	13	8	13	8	7	

[Note 1] Applies to open type bearings.

[Note 2] Applies to ball bearings.

Remark: The low outside diameter deviation of bearings in Table 3.2 does not apply within a distance from the ring face of $1.2 \times r$ max of the chamfer.

3-2 Tolerance for Thrust Load Angular Contact Ball Bearings (TAH/TBH Series)

Except for the outside diameter of outer ring outside diameter, accuracy of angular contact ball bearings for thrust loads conforms to JIS Class 4. Outside diameter of outer ring tolerances is as shown in Table 3.3.

● Table 3.3 Tolerance of Outside Diameter

Unit: μm

Nominal bearing outside diameter D (mm)		Outside diameter deviation ΔD_s	
Over	Incl.	Upper	Lower
50	80	-30	-49
80	120	-36	-58
120	180	-43	-68
180	250	-50	-79
250	315	-56	-88

3-3 Tolerances for Cross Tapered Roller Bearings

Tolerances for cross tapered roller bearings is shown in Table 3.4 and Table 3.5.

● Table 3.4 XRN Series Inner Ring and Outer Ring tolerances

Unit: μm

Bearing No.	Single plane mean bore diameter variation Δd_{mp}		Single plane mean outside diameter variation of outer ring ΔD_{mp}		Variation of assembled height T 's		Outer ring run-out max	
	Upper	Lower	Upper	Lower	Upper	Lower	Radial run-out	Sideface runout
150XRN23	0	-13	0	-15	+350	-250	7	7
200XRN28	0	-15	0	-18	+350	-250	7	7
250XRN33	0	-15	0	-18	+350	-250	7	7
250XRN35	0	-10	0	-13	+350	-250	9	9
300XRN40	0	-13	0	-15	+350	-250	7	7
310XRN42	0	-13	0	-15	+350	-250	7	7
0330XRN045	+25	0	+25	0	+350	-250	8	8
350XRN47	0	-13	0	-15	+350	-250	9	9
375XRN49	0	-13	0	-15	+350	-250	7	7
400XRN55	0	-13	0	-18	+350	-250	9	9
0457XRN060	+25	0	+25	0	+380	-380	9	9
580XRN76	+25	0	+38	0	+406	-406	10	10
0685XRN091	+38	0	+38	0	+508	-508	12	12
950XRN117	0	-75	0	-75	+750	-750	14	14

● Table 3.5 XRG (XRGV) Series Inner Ring and Outer Ring Tolerances

Unit: μm

Bearing No.	Single plane mean bore diameter variation Δd_{mp}		Single plane mean outside diameter variation of outer ring ΔD_{mp}		Variation of assembled height T 's		Inner ring run-out max	
	Upper	Lower	Upper	Lower	Upper	Lower	Radial run-out	Sideface runout
130XRG23	0	-10	0	-15	+350	-250	6	7
140XRGV20	0	-13	0	-15	+350	-350	5	5
150XRG23	0	-13	0	-15	+350	-250	6	7
200XRGV028	0	-15	0	-18	+350	-350	7	7
320XRG43	0	-13	0	-15	+350	-250	7	7
480XRGV66	0	-45	-70	-100	+450	-450	11	11

3-4 Tolerances for Ball Screw Support Bearing (TAB/TAU series)

Tolerances for ball screw support (TAB/TAU Series) is shown in Table 3.6 and Table 3.7.

● Table 3.6 Tolerances for Inner Ring (Including Outer Ring Width and Outer Ring Sideface Runout Reference to Raceway)

Nominal bearing bore diameter <i>d</i> (mm)	Single plane mean bore and bore variation $\Delta_{dmp}, \Delta_{ds}$		Bore diameter variation in a single radial plane V_{dp}		Mean bore diameter variation V_{dmp}		Deviation of a single inner ring width (or a single outer ring width) Δ_{Bs}, Δ_{Cs}		Width deviation of Inner ring V_{Bs}		Radial runout of assembled bearing inner ring K_{ia}		Side face runout S_4 with reference to bore		Side face runout with reference to raceway of assembled bearing inner ring S_{ia} and of assembled bearing outer ring S_{ea}				
																	Class 5		Class 4
	Over	Incl.	Upper	Lower	Upper	Lower	max	max	max	max	max	max	max	max	max	max	max		
10	18	0	-5	0	-4	4	3	3	2	0	-80	5	2.5	4	2.5	7	3	4	2
18	30	0	-6	0	-5	5	4	3	2.5	0	-120	5	2.5	4	3	8	4	5	2.5
30	50	0	-8	0	-6	6	5	4	3	0	-120	5	3	5	4	8	4	6	2.5
50	80	0	-9	0	-7	7	5	5	3.5	0	-150	6	4	5	4	8	5	7	2.5

● Table 3.7 Tolerances for Outer Ring

Nominal bearing outside diameter <i>D</i> (mm)	Single plane mean outside diameter variation of outer ring $\Delta_{Dmp}, \Delta_{Ds}$		Outside diameter variation in a single radial plane V_{Dp}		Mean outside diameter variation V_{Dmp}		Outer ring width variation V_{Cs}		Outer ring radial runout of assembled bearing K_{ea}		Variation of outside surface generatrix inclination with outer ring reference S_D				
													Class 5		Class 4
	Over	Incl.	Upper	Lower	Upper	Lower	max	max	max	max	max	max	max		
30	50	0	-7	0	-6	5	5	4	3	5	2.5	7	5	8	4
50	80	0	-9	0	-7	7	5	5	3.5	6	3	8	5	8	4
80	120	0	-10	0	-8	8	6	5	4	8	4	10	6	9	5

For TAB flush ground type, P4, tighter tolerances of outside and bore diameter are available as option to minimize dimensional difference within combination bearings.

● Table 3.8 Tolerances for Bore Diameter of Inner Ring (P4F)

Nominal bearing bore diameter <i>d</i> (mm)	Single plane mean bore diameter variation $\Delta_{dmp}, \Delta_{ds}$	
	Class 4 flush ground	
Over	Incl.	Lower
10	18	-4
18	30	-4
30	50	-4
50	80	-5

Tolerances for other than bore diameter conforms to Class 4 in Table 3.6.

● Table 3.9 Tolerance for Outside Diameter of Outer Ring (P4F)

Nominal bearing outside diameter <i>D</i> (mm)	Single plane mean outside diameter variation of outer ring $\Delta_{Dmp}, \Delta_{Ds}$	
	Class 4 flush ground	
Over	Incl.	Lower
30	50	-4
50	80	-5
80	120	-6

Tolerances for other than outside diameter conforms to Class 4 in Table 3.7.

3-5 Tolerances for Ball Screw Support Bearings (TAF-X series)

Tolerances for ball screw support (TAF-X Series) is shown in Table 3.10 and Table 3.11.

● Table 3.10 Tolerances for Inner Ring (Including Outer Ring Width, Equivalent JIS Class 5)

Nominal bearing bore diameter <i>d</i> (mm)	Single plane mean bore diameter variation Δ_{dmp}		Bore diameter variation in a single radial plane V_{dp}		Mean bore diameter variation V_{dmp}		Outer and inner ring width variation Δ_{Bs}, Δ_{Cs}		Width deviation of Inner Ring V_{Bs}		Radial runout of assembled bearing inner ring K_{ia}		Side face runout with reference to bore S_d		Side face runout with reference to raceway of assembled bearing inner ring S_{ia}	
18	30	0	-6	5	3	0	-120	5	4	8	8					
30	50	0	-8	6	4	0	-120	5	5	8	8					
50	80	0	-9	7	5	0	-150	6	5	8	8					
80	120	0	-10	8	5	0	-200	7	6	9	9					

● Table 3.11 Tolerances for Outer Ring (Equivalent JIS Class 5)

Nominal bearing outside diameter <i>D</i> (mm)	Single plane mean outside diameter variation of outer ring Δ_{Dmp}		Outside diameter variation in a single radial plane V_{Dp}		Mean outside diameter variation V_{Dmp}		Outer ring width variation V_{Cs}		Outer ring radial runout of assembled bearing K_{ea}		Variation of outside surface generatrix inclination with outer ring reference S_D		Assembled bearing outer ring reference face runout with raceway S_{ea}	
50	80	0	-9	7	5	6	8	8	10					
80	120	0	-10	8	5	8	10	9	11					
120	150	0	-11	8	6	8	11	10	13					
150	180	0	-13	10	7	8	13	10	14					
180	250	0	-15	11	8	10	15	11	15					
250	315	0	-18	14	9	11	18	13	18					

3-6 Tolerances for Tapered Bore Cylindrical Roller Bearings

Tolerances for tapered bores (Cylindrical roller bearings) is specified by JIS. Since JIS tolerances are rather broad, NACHI defines its own narrower range for precision bearings.

● Table 3.12 Tolerances for Tapered Bores (Cylindrical Roller Bearings)

Nominal bearing bore diameter <i>d</i> (mm)	Mean bore diameter deviation at theoretical small end of a tapered bore								Bore diameter variation in a single plane radial plane		
	Δ_{dmp}				$\Delta_{d1mp} - \Delta_{dmp}$				V_{dp}		
	Class 5		Class 4		Class 5		Class 4		Class 5	Class 4	
Over	Incl.	Upper	Lower	Upper	Lower	Upper	Lower	Upper	Lower	max	max
18	30	+10	0	+6	0	+5	0	+3	0	3	3
30	50	+12	0	+8	0	+5	0	+4	0	4	3
50	80	+15	0	+9	0	+6	0	+4	0	5	4
80	120	+20	0	+10	0	+7	0	+5	0	5	4
120	180	+25	0	+13	0	+10	0	+7	0	7	5
180	250	+30	0	+15	0	+12	0	+9	0	8	6
250	315	+35	0	+18	0	+15	0	+11	0	9	9
315	400	+40	0	+23	0	+16	0	+12	0	12	12

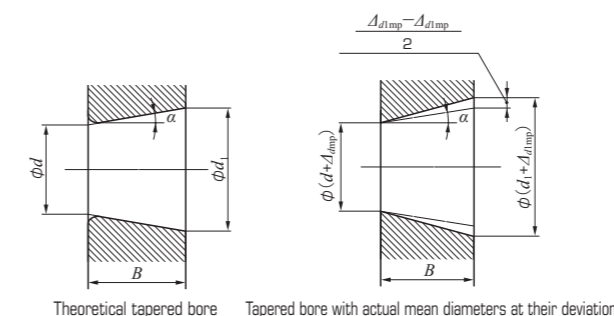

Figure 3.1 Tapered Bores of Cylindrical Roller Bearings

d : Nominal bearing bore diameter
*d*₁ : Basic diameter at theoretical large end of tapered bore
 $d_1 = d + \frac{1}{12} B$
 Δ_{dmp} : Mean bore diameter deviation at theoretical small end of tapered bore
 Δ_{d1mp} : Mean bore diameter deviation at theoretical large end of tapered bore
B : Nominal bearing inner ring width
 α : Nominal taper angle (half of cone angle)











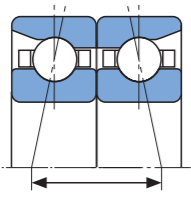



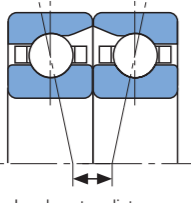



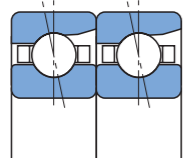

4. Bearing Arrangement

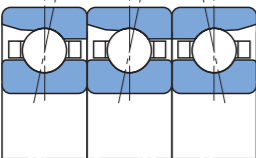
4-1 Features of Bearing Arrangement

In addition to a duplex set, precision angular contact ball bearings and ball screw support bearings are available in 3-row duplex and 4-row duplex. Bearings in these combinations are manufactured in sets with a desired preload and dimensional variation of outside diameter

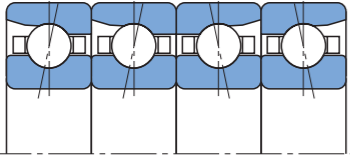
and bore diameter within the bearing sets are controlled. Because of this, avoid switching the duplex bearings in a set with other bearings. Table 4.1 shows the main combinations and describes their characteristics.

● Table 4.1 Main Combinations and Characteristics

Main combinations	Cross section	Load capability	Moment load rigidity	Speed	Features
Back-to-back (DB)					<ul style="list-style-type: none"> ● Radial loads and axial loads in both directions can be applied. ● The load center distance is long, so moment load capability is high. ● Misalignment or other mounting error increases internal load and tends to generate premature flaking.
Face-to-face (DF)					<ul style="list-style-type: none"> ● The load center distance is decreased, so moment load capability is low. ● Since moment load capability is low, increase in internal load due to misalignment is kept under control. Because of this, this combination is suitable when misalignment can not be avoided or when shaft deflection is large because of the load.
Tandem (DT)					<ul style="list-style-type: none"> ● Radial loads and axial loads can be applied in one direction. ● Since the axial load capability is double that of a single row, this combination is suitable for large axial load in one-direction.
3-row duplex (FFB)					<ul style="list-style-type: none"> ● Radial loads and axial loads in both direction can be applied. ● The axial load capability is double that of a single-row, but preload is not distributed uniformly to each bearing, and the single-row configuration is double that of the two-row configuration. This non-uniform preload distribution makes appropriate preload settings difficult at high speed rotation.
4-row duplex (FFBB)					<ul style="list-style-type: none"> ● Radial loads and axial loads in both directions can be applied. ● Compared to the back-to-back configuration under the same preload clearance, preload is doubled and rigidity is greater.

4-2 Mounting and Mounting Symbols

The symbols used for each type of combination are shown in Table 4.1. The arrangement sequence and direction of the load are important for duplex bearings. Because of this, the outside surface of the outer ring of the duplex bearings in Figure 4.1 has a combination mark (<) that can be used to check the arrangement sequence. If the bearings are arranged in the correct sequence, the

marks on the outside surface of each bearing appear as a "<". Regarding the combinations of back (DB), face (DF), and tandem (DT) for sealed ball screw support bearings, there are no combination marks on the outside surface of the outer rings because combinations can be confirmed by keeping the sealed face on the outside.

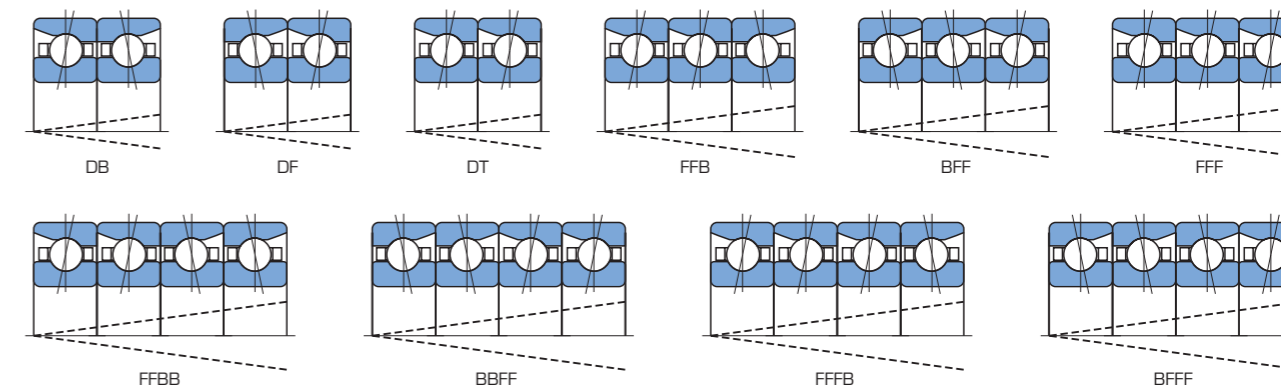

Figure 4.1 Set Combinations and Outer Ring Combination Marks

4-3 Flush Ground Angular Contact Ball Bearings

For flush ground angular contact ball bearings, the face side width dimension (Af) and back side width dimension (Ab) are controlled to be the same. Therefore, desired preload is obtained in any set of combination. (Figure 4.2). Flush ground angular contact ball bearings are delivered singularly (suffix symbol; U) or in a duplex set (suffix symbol DU). Duplex sets have a small dimensional variation in bore diameter and outer diameter. When using U series in a combination, select a bearing whose actual measured outside diameter and bore diameter values are close to each other. For the angular contact ball bearings and ball screw support bearing flush ground type, a combination (<) mark is put on the outside surface of the outer ring. For information about set combinations and the combination marks, see Figure 4.3.

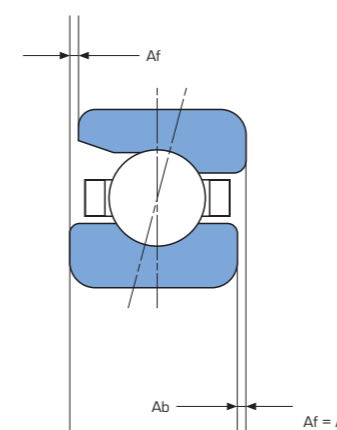

Figure 4.2 Flush Ground Angular Contact Ball Bearing

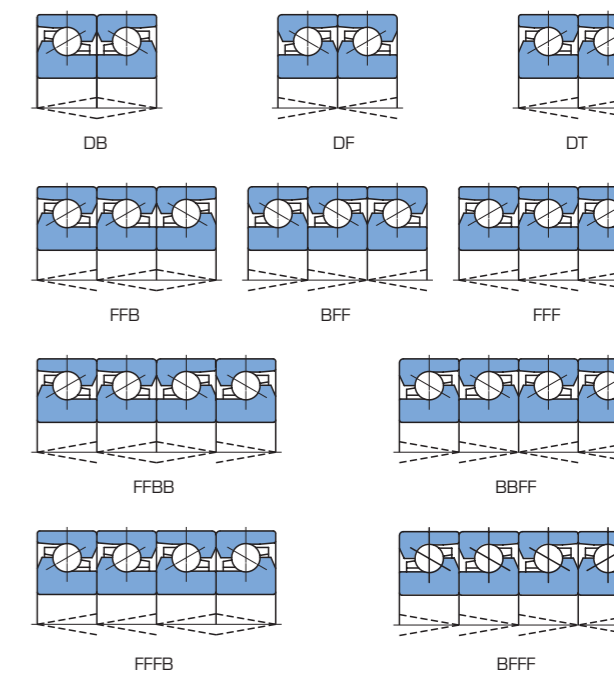

Figure 4.3 Flush Ground Bearing Set Combinations and Combination Marks (For angular contact ball bearings and ball screw support bearings)

5. Preload and Rigidity

5-1 Preload Objectives

Rolling contact bearings generally have internal clearance suitable for operating conditions, angular contact ball bearings also may be installed with appropriate predetermined negative clearance (axial preload). This is known as "preload". Care is required when determining preloads. An improper preload can increase friction torque, raise temperature, cause abnormal sounds, shorten bearing life, and cause other problems.

The following is a list of what can be achieved by preloading.

- Reduced axial displacement due to external force and greater axial rigidity
- Prevention of vibration and noise and increased speed due to greater axial rigidity
- Less chance of fretting due to external vibration
- Smooth rolling rotation
- Lower noise and less heat due to ball centrifugal force and gyro-moment

Gyro-moment

The balls of an angular contact ball bearing spin around rotational axes while they revolve around an orbital axis (axis line). An angle is formed between the rotational axis and orbital axis, and a moment is generated when a ball attempts to revolve on the center of the two different axes. This is called a "gyro-moment" (Figure 5.1).

The size of the gyro-moment is proportional to rotational angular velocity and orbital angular velocity. Gyro-moment is small enough to be ignored at low-speed rotation, but heat generation due to slipping caused by gyro-motion in the high-speed rotation range cannot be ignored. In order to suppress slipping caused by gyro-motion, friction (ball load x coefficient of friction) between the balls and raceway surface must be maintained. This means that there are times when minimal preload can be chosen.

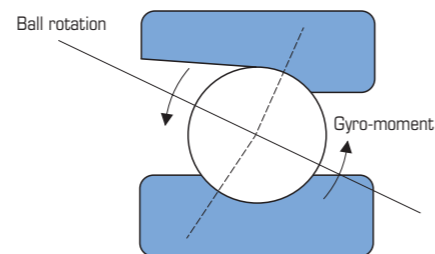

Figure 5.1 Gyro-moment

face

5-2 Preload Methods

Preloading combination bearings is broadly divided between fixed-position preload and fixed-pressure preload. Table 5.1 (Page 18) shows graphic examples and describes the characteristics of each type of preloading. A cylindrical roller bearing with tapered bore also may be used with radial preload (negative radial clearance) applied. However, caution is required because radial preload that is too large dramatically reduces service life (Figure 5.2).

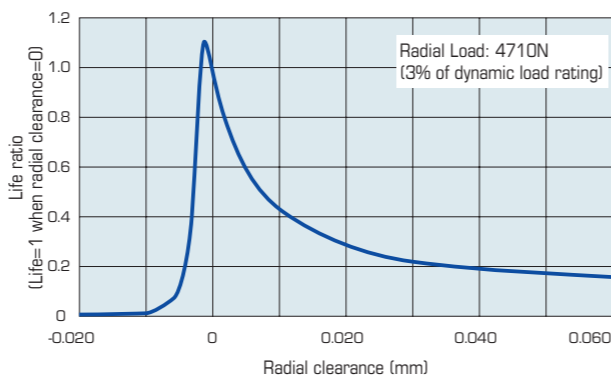

Figure 5.2 Cylindrical Roller Bearing (NN3020) Radial Clearance and Service Life

5-3 Measuring Preload

① Axial load measurement method

For spring preloading (fixed-pressure preload), the preload is known if the spring displacement is known. For nut preloading (fixed-position preload), the preload can be determined based on the relationship between nut tightening torque and tightening force. However, caution is required because there is wide variation in the relationship between nut tightening torque and tightening force due to accuracy and roughness of the threaded portion.

② Axial displacement measurement method

The preload can be determined based on the relationship between the axial load on the bearing and axial displacement.

③ Bearing starting friction torque measurement method

To perform this measurement, your first need to create a graph of the load and starting torque of the bearing itself. However, caution is required because of variation due to bearing type, lubrication conditions, etc.

● Table 5.1 Preload Methods

Preload methods	Design example	Features
Fixed-position preload	 Method using either a duplex bearing with pre-adjusted preload or a dimension adjusted spacer	<ul style="list-style-type: none"> ● Since bearing spread is used, the prescribed preload can be obtained simply by tightening a nut. ● Fit causes preload inconsistency. ● Heat generation causes preload inconsistency. ● Applying an axial load that is too great can cause loss of preload.
	 Preload adjustment method using nut tightening	<ul style="list-style-type: none"> ● Uniform preload, even if fit is inconsistent ● Further tightening possible ● Heat generation causes preload inconsistency. ● Applying an axial load that is too great can cause loss of preload.
Fixed-pressure preload	 Method using spring	<ul style="list-style-type: none"> ● Constant uniform preload while running ● No loss of preload ● Suitable for high speeds ● In principle, one-direction axial load can be applied ● Inferior rigidity compared to fixed-position preload of the same preload

5-4 Preload Effect

Graphic analysis of load distribution and axial displacement on two bearings when preload is applied with an external load, as shown in Figure 5.3, is performed as described below.

- ① Graph the Axial Load T - Axial Deflection δ_a curve for bearing A.
- ② Locating preload T_p on the T-axis, determine the point of intersection for bearing A curve, and then graph the T - δ_a curve for Bearing B point P.
- ③ Link the above two curves horizontally along the T-axis for a length that corresponds to the external load value T_w .
- ④ Loads T_a and T_b , which correspond to the points of intersection of the lines, are the loads of each bearing under external load conditions.

⑤ Axial displacement is given as bearing B displacement δ_w . (Bearing B displacement is the displacement for T_p subtracted from the displacement for T_b .)

The reason for this is that the displacements of two preloaded bearings are not uniform within the range that the preload does not become zero due to outside load. (Figure 5.3 is uniform). In other words, bearing A is displaced only as much as bearing B is displaced by the external load.

After external load becomes great and preload is eliminated, bearing B load T_b becomes the same as external load T_w , and bearing A load is eliminated. The size of the external load when this preload is eliminated is indicated in Figure 5.3 as T_{po} .

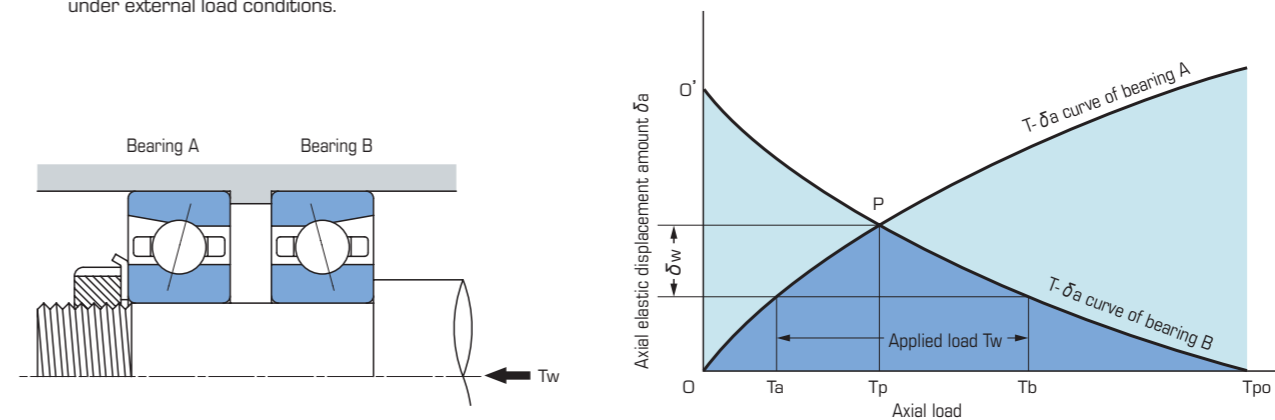

Figure 5.3 Fixed-position Preload

5-5 Standard Preload and Axial Rigidity

5.5.1 Angular Contact Ball Bearing

Preloads and axial rigidity for face-to-face and back-to-back duplex mounting are shown in Table 5.3 1 to 6 (P.19 through 21). Preloads for multiple-row arrangements can be obtained by multiplying by the coefficients in Table 5.2.

● Table 5.2 Preload Factors for Multiple-row Arrangements

3-row arrangement	4-row arrangement	
FFB · BFF	FFFB · BFFF	FFBB · BBFF
1.36	1.57	2

● Table 5.3

1 7900C Series, Contact Angle 15°

Bore diameter number	E preload (extra-light preload)		L preload (light preload)		M preload (medium preload)	
	Preload (N)	Axial rigidity (N/μm)	Preload (N)	Axial rigidity (N/μm)	Preload (N)	Axial rigidity (N/μm)
00	5	10	15	15	30	20
01	7	12	20	18	40	24
02	8	13	25	21	50	28
03	8	13	25	21	50	28
04	15	19	40	27	80	36
05	15	19	50	33	100	43
06	15	21	50	36	100	48
07	25	28	70	41	140	56
08	25	28	80	44	155	60
09	35	35	100	53	195	70
10	35	35	100	56	195	72

2 7900AC Series, Contact Angle 25°

Bore diameter number	L preload (light preload)		M preload (medium preload)		H preload (heavy preload)	
	Preload (N)	Axial rigidity (N/μm)	Preload (N)	Axial rigidity (N/μm)	Preload (N)	Axial rigidity (N/μm)
00	20	33	88	59	196	82
01	20	33	98	65	216	90
02	29	42	108	67	235	94
03	29	42	118	74	255	102
04	59	65	235	107	490	149
05	69	69	265	120	560	169
06	78	78	294	134	628	190
07	88	88	323	147	785	212
08	88	98	412	165	1,000	244
09	98	109	470	188	1,040	260
10	118	118	520	208	1,140	284

3 7000C Series, Contact Angle 15°

Bore diameter number	E preload (extra-light preload)		L preload (light preload)		M preload (medium preload)		H preload (heavy preload)	
	Preload (N)	Axial rigidity (N/μm)	Preload (N)	Axial rigidity (N/μm)	Preload (N)	Axial rigidity (N/μm)	Preload (N)	Axial rigidity (N/μm)
00	20	13	50	20	100	29	145	37
01	20	14	50	21	100	31	145	39
02	20	15	50	23	100	34	145	42
03	20	16	50	25	100	35	145	43
04	50	23	100	33	195	48	295	59
05	50	26	100	36	195	50	295	63
06	50	27	100	38	195	53	390	75
07	70	33	145	46	295	64	390	75
08	70	34	145	49	295	68	590	98
09	70	34	145	49	295	68	590	98
10	70	36	145	51	295	70	590	100
11	100	43	195	56	390	78	785	112
12	100	43	195	58	390	82	785	115
13	100	47	195	61	390	85	785	123
14	145	57	295	75	590	105	1,170	149
15	145	57	295	77	590	107	1,170	153
16	145	57	295	75	590	105	1,170	149
17	195	65	390	89	785	125	1,470	171
18	195	65	390	87	785	121	1,470	165
19	195	68	390	91	785	125	1,470	171
20	195	70	390	93	785	127	1,470	173

4 7000AC Series, Contact Angle 25°

Bore diameter number	L preload (light preload)		M preload (medium preload)		H preload (heavy preload)	
	Preload (N)	Axial rigidity (N/μm)	Preload (N)	Axial rigidity (N/μm)	Preload (N)	Axial rigidity (N/μm)
00	39	39	118	62	314	95
01	39	44	127	67	343	104
02	49	49	157	83	353	118
03	59	59	216	98	520	144
04	59	59	274	110	608	152
05	108	83	392	140	804	187
06	118	91	441	158	892	208
07	127	98	539	174	1,156	236
08	147	113	617	193	1,176	256
09	216	135	745	213	1,646	300
10	225	141	784	224	1,744	317
11	314	157	1,040	254	2,078	341
12	333	167	1,098	268	2,205	362
13	363	191	1,225	299	2,450	402
14	392	196	1,460	332	3,010	443
15	412	206	1,530	348	3,155	464
16	529	230	1,900	373	3,880	504
17	549	239	1,990	390	4,080	530
18	676	260	2,185	405	4,600	555
19	706	272	2,300	427	4,810	580
20	745	287	2,400	445	5,050	608

Preload and Rigidity

5 7200C Series, Contact Angle 15°

Bore diameter number	E preload (extra-light preload)		L preload (light preload)		M preload (medium preload)		H preload (heavy preload)	
	Preload (N)	Axial rigidity (N/μm)	Preload (N)	Axial rigidity (N/μm)	Preload (N)	Axial rigidity (N/μm)	Preload (N)	Axial rigidity (N/μm)
00	30	16	70	24	145	36	195	42
01	30	16	70	24	145	36	195	42
02	30	17	70	25	145	38	195	44
03	30	17	70	25	145	37	195	44
04	70	25	145	37	295	53	490	71
05	70	29	145	41	295	58	490	77
06	70	29	145	41	295	58	590	83
07	100	35	195	47	490	74	590	82
08	100	36	195	49	490	77	785	98
09	100	36	195	50	490	77	785	98
10	100	39	195	52	490	80	785	102
11	145	46	295	63	590	88	980	114
12	145	46	295	61	590	84	980	109
13	145	47	295	64	590	88	980	113
14	195	54	390	73	785	102	1,470	139
15	195	56	390	75	785	105	1,470	144
16	195	58	390	77	785	105	1,470	143
17	295	68	490	85	980	117	1,960	166
18	295	67	490	83	980	114	1,960	161
19	295	68	490	85	980	114	1,960	159
20	295	68	490	85	980	115	1,960	159

6 7200AC Series, Contact Angle 25°

Bore diameter number	L preload (light preload)		M preload (medium preload)		H preload (heavy preload)	
	Preload (N)	Axial rigidity (N/μm)	Preload (N)	Axial rigidity (N/μm)	Preload (N)	Axial rigidity (N/μm)
00	39	44	186	78	412	108
01	39	44	196	78	421	111
02	69	57	265	95	530	129
03	78	60	274	98	628	143
04	118	74	420	120	853	164
05	147	92	430	139	922	188
06	157	92	628	165	1,314	227
07	225	119	853	194	1,890	270
08	255	127	950	216	1,960	288
09	333	145	1,200	241	2,470	321
10	353	153	1,295	259	2,655	345
11	460	177	1,500	278	3,145	379
12	540	186	1,600	280	3,410	383
13	600	206	2,069	328	4,175	440
14	610	210	2,108	335	4,260	444
15	650	223	2,255	358	4,310	464
16	800	241	2,725	389	5,730	531
17	940	262	2,970	407	6,090	549
18	1,200	285	3,745	441	7,620	591
19	1,235	294	3,870	450	8,140	612
20	1,588	324	4,930	503	9,950	677

5.5.2 High-speed Angular Contact Ball Bearings

● Table 5.4 BNH000 Series, Contact Angle 15°

Bore diameter number	Bore diameter (mm)	L preload (light preload)	
		Preload (N)	Axial rigidity (N/μm)
07	35	78.5	44
08	40	98.1	49
09	45	98.1	52
10	50	98.1	54
11	55	147	61
12	60	147	64
13	65	147	67
14	70	245	88
15	75	245	91
16	80	294	98
17	85	294	98
18	90	392	115
19	95	392	119
20	100	392	123
21	105	490	136
22	110	588	144
24	120	588	147
26	130	785	163
28	140	834	174
30	150	1,080	200
32	160	1,180	206
34	170	1,370	221

5.5.3 Thrust Load Angular Contact Ball Bearings

● Table 5.5

1 TAH Series, Contact Angle 30°

Nominal bore diameter (mm)	M preload (medium preload)	
	Preload (N)	Axial rigidity (N/μm)
50	294	226
55	392	262
60	392	280
65	392	280
70	588	327
75	588	327
80	686	361
85	686	361
90	1,080	449
95	1,080	449
100	1,080	469
105	1,180	490
110	1,370	528
120	1,470	566
130	1,860	621
140	1,960	654
150	2,450	721
160	2,650	779
170	3,040	800

2 TBH Series, Contact Angle 40°

Nominal bore diameter (mm)	M preload (medium preload)	
	Preload (N)	Axial rigidity (N/μm)
50	539	415
55	686	458
60	686	490
65	686	528
70	1,080	599
75	1,080	599
80	1,270	671
85	1,270	671
90	1,860	776
95	1,860	810
100	1,860	847
105	2,060	858
110	2,450	943
120	2,550	1,020
130	3,330	1,111
140	3,530	1,177
150	4,310	1,269
160	4,510	1,367
170	5,300	1,431

Preload and Rigidity

5.5.4 Ball Screw Support Bearings

● Table 5.6

1 TAB Series, Contact Angle 60°, L preload (light preload)

Bearing No.	2-row arrangement			3-row arrangement			4-row arrangement					
	DB/DF			FFB/BFF			FFBB/BBFF			FFFB/BFFF		
	Preload (N)	Axial rigidity (N/μm)	Starting torque (N·cm)	Preload (N)	Axial rigidity (N/μm)	Starting torque (N·cm)	Preload (N)	Axial rigidity (N/μm)	Starting torque (N·cm)	Preload (N)	Axial rigidity (N/μm)	Starting torque (N·cm)
15TAB04	1,080	540	10	1,470	800	11	2,160	1,080	16	1,700	1,020	12
17TAB04	1,080	540	10	1,470	800	11	2,160	1,080	16	1,700	1,020	12
20TAB04	1,080	540	10	1,470	800	11	2,160	1,080	16	1,700	1,020	12
25TAB06	1,665	757	15	2,260	1,130	20	3,330	1,510	30	2,610	1,430	23
30TAB06	1,665	757	15	2,260	1,130	20	3,330	1,510	30	2,610	1,430	23
35TAB07	1,960	933	20	2,670	1,390	27	3,920	1,870	40	3,080	1,760	31
40TAB07	1,960	933	20	2,670	1,390	27	3,920	1,870	40	3,080	1,760	31
40TAB09	2,600	1,000	30	3,540	1,490	41	5,200	2,000	60	4,080	1,890	47
45TAB07	2,060	981	20	2,800	1,460	27	4,120	1,960	40	3,230	1,850	31
45TAB10	2,990	1,107	35	4,070	1,650	47	5,980	2,210	70	4,690	2,090	54
50TAB10	3,140	1,163	40	4,270	1,730	54	6,280	2,330	80	4,930	2,200	62
55TAB10	3,140	1,163	40	4,270	1,730	54	6,280	2,330	80	4,930	2,200	62
55TAB12	3,530	1,358	45	4,800	2,020	61	7,060	2,720	90	5,540	2,570	70
60TAB12	3,530	1,358	45	4,800	2,020	61	7,060	2,720	90	5,540	2,570	70

2 TAB Series, Contact Angle 60°, M preload (medium preload)

Bearing No.	2-row arrangement			3-row arrangement			4-row arrangement					
	DB/DF			FFB/BFF			FFBB/BBFF			FFFB/BFFF		
	Preload (N)	Axial rigidity (N/μm)	Starting torque (N·cm)	Preload (N)	Axial rigidity (N/μm)	Starting torque (N·cm)	Preload (N)	Axial rigidity (N/μm)	Starting torque (N·cm)	Preload (N)	Axial rigidity (N/μm)	Starting torque (N·cm)
15TAB04	2,160	735	15	2,940	1,080	20	4,310	1,470	30	3,430	1,320	25
17TAB04	2,160	735	15	2,940	1,080	20	4,310	1,470	30	3,430	1,320	25
20TAB04	2,160	735	15	2,940	1,080	20	4,310	1,470	30	3,430	1,320	25
25TAB06	3,330	981	20	4,510	1,470	27	6,670	1,960	40	5,200	1,910	30
30TAB06	3,330	981	20	4,510	1,470	27	6,670	1,960	40	5,200	1,910	30
35TAB07	3,920	1,230	25	5,300	1,770	35	7,840	2,350	50	6,180	2,300	40
40TAB07	3,920	1,230	25	5,300	1,770	35	7,840	2,350	50	6,180	2,300	40
40TAB09	5,200	1,320	50	7,060	1,910	68	10,400	2,550	100	8,140	2,500	80
45TAB07	4,120	1,270	30	5,590	1,910	40	8,240	2,550	60	6,470	2,500	45
45TAB10	5,980	1,470	60	8,140	2,160	82	12,000	2,890	120	9,410	2,790	95
50TAB10	6,280	1,520	65	8,530	2,260	88	12,600	3,040	130	9,810	2,940	100
55TAB10	6,280	1,520	65	8,530	2,260	88	12,600	3,040	130	9,810	2,940	100
55TAB12	7,060	1,770	70	9,610	2,550	95	14,100	3,480	140	11,100	3,380	110
60TAB12	7,060	1,770	70	9,610	2,550	95	14,100	3,480	140	11,100	3,380	110

3 TAU Series, Contact Angle 60°, M preload (medium preload)

Bearing No.	Preload (N)	Axial rigidity (N/μm)	Starting torque (N·cm)
15TAU06F	1,000	400	5
17TAU06F	1,180	450	5
20TAU06F	2,160	650	10
25TAU07F	2,350	750	15
30TAU08F	2,550	850	15
30TAU10F	4,310	950	30
35TAU09F	2,550	900	15
40TAU10F	3,230	1,000	20
40TAU11F	7,200	1,200	60
50TAU11F	4,210	1,250	30
50TAU14F	7,850	1,400	70
60TAU14F	4,980	1,300	40

4 TAF-X Series, Contact Angle 55°, E preload (extra-light preload)

Bearing No.	2-row arrangement			3-row arrangement			4-row arrangement					
	DB/DF			FFB/BFF			FFBB/BBFF			FFFB/BFFF		
	Preload (N)	Axial rigidity (N/μm)	Starting torque (N·cm)	Preload (N)	Axial rigidity (N/μm)	Starting torque (N·cm)	Preload (N)	Axial rigidity (N/μm)	Starting torque (N·cm)	Preload (N)	Axial rigidity (N/μm)	Starting torque (N·cm)
25TAF05X	80	240	0.4	110	360	0.5	160	480	0.8	130	450	0.5
25TAF06X	120	255	0.7	160	380	0.9	240	510	1.4	190	480	1
30TAF07X	180	345	1	240	510	2	360	690	2	280	650	1.5
35TAF09X	270	410	2	370	610	3	540	820	4	420	770	3
40TAF09X	270	410	2	370	610	3	540	820	4	420	770	3
40TAF11X	410	510	3	560	760	4	820	1,020	6	640	960	4
45TAF10X	320	450	3	440	670	3	640	900	6	500	850	4
45TAF11X	410	510	3	560	760	4	820	1,020	6	640	960	4
50TAF11X	410	510	3	560	760	4	820	1,020	6	640	960	4
50TAF13X	550	600	5	750	890	7	1,100	1,200	10	860	1,130	8
60TAF13X	550	600	5	750	890	7	1,100	1,200	10	860	1,130	8
60TAF17X	890	780	10	1,210	1,160	13	1,780	1,560	20	1,400	1,470	15
80TAF17X	890	780	10	1,210	1,160	13	1,780	1,560	20	1,400	1,470	15
80TAF21X	1,390	930	20	1,890	1,390	25	2,780	1,860	40	2,180	1,760	30
100TAF21X	1,390	930	20	1,890	1,390	25	2,780	1,860	40	2,180	1,760	30
100TAF26X	1,960	1,000	30	2,670	1,490	40	3,920	2,000	60	3,080	1,890	50
120TAF26X	1,960	1,000	30	2,670	1,490	40	3,920	2,000	60	3,080	1,890	50

5 TAF-X Series, Contact Angle 55°, L preload (light preload)

Bearing No.	2-row arrangement			3-row arrangement			4-row arrangement					
	DB/DF			FFB/BFF			FFBB/BBFF			FFFB/BFFF		
	Preload (N)	Axial rigidity (N/μm)	Starting torque (N·cm)	Preload (N)	Axial rigidity (N/μm)	Starting torque (N·cm)	Preload (N)	Axial rigidity (N/μm)	Starting torque (N·cm)	Preload (N)	Axial rigidity (N/μm)	Starting torque (N·cm)
25TAF05X	310	385	1.5	420	570	2	620	770	3	490	730	2
25TAF06X	460	390	3	630	580	4	920	780	6	720	740	5
30TAF07X	660	490	5	900	730	6	1,320	980	10	1,040	930	7
35TAF09X	1,000	495	10	1,360	740	10	2,000	990	20	1,570	940	15
40TAF09X	1,000	495	10	1,360	740	10	2,000	990	20	1,570	940	15
40TAF11X	1,550	795	15	2,110	1,180	20	3,100	1,590	30	2,430	1,500	25
45TAF10X	1,200	680	10	1,630	1,010	15	2,400	1,360	20	1,890	1,290	15
45TAF11X	1,550	795	15	2,110	1,180	20	3,100	1,590	30	2,430	1,500	25
50TAF11X	1,550	795	15	2,110	1,180	20	3,100	1,590	30	2,430	1,500	25
50TAF13X	2,070	920	25	2,820	1,370	30	4,140	1,840	50	3,250	1,740	35
60TAF13X	2,070	920	25	2,820	1,370	30	4,140	1,840	50	3,250	1,740	35
60TAF17X	3,350	1,180	45	4,560	1,760	65	6,700	2,360	90	5,260	2,230	70
80TAF17X	3,350	1,180	45	4,560	1,760	65	6,700	2,360	90	5,260	2,230	70
80TAF21X	5,200	1,030	90	7,070	1,530	120	10,400	2,060	180	8,160	1,950	140
100TAF21X	5,200	1,030	90	7,070	1,530	120	10,400	2,060	180	8,160	1,950	140
100TAF26X	7,500	1,800	150	10,200	2,680	250	15,000	3,600	300	11,800	3,400	235
120TAF26X	7,500	1,800	150	10,200	2,680	250	15,000	3,600	300	11,800	3,400	235

6 TAF-X Series, Contact Angle 55°, M preload (medium preload)

Bearing No.	2-row arrangement			3-row arrangement			4-row arrangement					
	DB/DF			FFB/BFF			FFBB/BBFF			FFFB/BFFF		
	Preload (N)	Axial rigidity (N/μm)	Starting torque (N·cm)	Preload (N)	Axial rigidity (N/μm)	Starting torque (N·cm)	Preload (N)	Axial rigidity (N/μm)	Starting torque (N·cm)	Preload (N)	Axial rigidity (N/μm)	Starting torque (N·cm)
25TAF05X	780	550	4	1,060	820	6	1,560	1,100	8	1,220	1,040	6
25TAF06X	1,160	535	8	1,580	780	11	2,320	1,070	16	1,820	1,010	12
30TAF07X	1,660	650	15	2,260	970	17	3,320	1,300	30	2,600	1,230	20
35TAF09X	2,530	870	25	3,440	1,300	31	5,060	1,740	50	3,970	1,640	36
40TAF09X	2,530	870	25	3,440	1,300	31	5,060	1,740	50	3,970	1,640	36
40TAF11X	3,900	1,080	45	5,300	1,610	60	7,800	2,160	90	6,120	2,040	68
45TAF10X	3,050	975	30	4,150	1,450	40	6,100	1,950	60	4,790	1,840	47
45TAF11X	3,900	1,080	45	5,300	1,610	60	7,800	2,160	90	6,120	2,040	68
50TAF11X	3,900	1,080	45	5,300	1,610	60	7,800	2,160	90	6,120	2,040	68
50TAF13X	5,200	1,270	70	7,070	1,890	90	10,400	2,540	140	8,160	2,400	110
60TAF13X	5,200	1,270	70	7,070	1,890	90	10,400	2,540	140	8,160	2,400	110
60TAF17X	8,400	1,580	140	11,400	2,350	190	16,800	3,160	280	13,200	2,990	220
80TAF17X	8,400	1,580	140	11,400	2,350	190	16,800	3,160	280	13,200	2,990	220

Preload and Rigidity

7 7000XYS1 Series, Contact Angle 30°, M preload (medium preload)

Bearing No.	2-row arrangement		
	DB/DF		
	Preload (N)	Axial rigidity (N/μm)	Starting torque (N·cm)
7000XYS1	147	92	0.6
7001XYS1	147	98	0.6
7002XYS1	147	98	0.7
7003XYS1	147	105	0.7
7004XYS1	294	147	1.8

9 7000W1 Series, Contact Angle 30°, M preload (medium preload)

Bearing No.	2-row arrangement		
	DF		
	Preload (N)	Axial rigidity (N/μm)	Starting torque (N·cm)
7000W1Y	147	77	0.3
7001W1Y	147	86	0.3
7002W1Y	147	98	0.3
7003W1Y	294	128	0.7
7004W1Y	294	134	0.8
7005W1Y	490	175	1.6

8 7200XYS1 Series, Contact Angle 30°, M preload (medium preload)

Bearing No.	2-row arrangement		
	DB/DF		
	Preload (N)	Axial rigidity (N/μm)	Starting torque (N·cm)
7203XYS1	294	140	1.8
7204XYS1	490	169	3.9
7205XYS1	490	188	3.9
7206XYS1	490	196	4.3

10 7200W1 Series, Contact Angle 30°, M preload (medium preload)

Bearing No.	2-row arrangement		
	DF		
	Preload (N)	Axial rigidity (N/μm)	Starting torque (N·cm)
7200W1Y	147	82	0.4
7201W1Y	147	82	0.4
7202W1Y	294	118	0.8
7203W1Y	294	118	0.9
7204W1Y	490	153	1.8
7205W1Y	490	169	1.8

5.5.5 Radial Internal Clearance for Double row Cylindrical Roller Bearings

The radial internal clearance for double row cylindrical roller bearings is specified by JIS, NACHI defines its own narrower range in order to maximize rotation accuracy. The radial internal clearances for cylindrical bore bearings

and tapered bore bearings are shown in Table 5.7. Also, caution is required when handling and installing bearings with non-interchangeable clearances, because there is no interchangeability with another bearing's outer ring or inner ring.

● Table 5.7

1 Cylindrical Bore Bearing Non-interchangeable Clearance

Unit: μm

Nominal bearing bore diameter d (mm)		Cylindrical bore bearing clearance (non-interchangeable)							
		C1na		C2na		Cna		C3na	
Over	Incl.	min	max	min	max	min	max	min	max
24	30	0	10	10	25	25	35	40	50
30	40	0	12	12	25	25	40	45	55
40	50	0	15	15	30	30	45	50	65
50	65	0	15	15	35	35	50	55	75
65	80	0	20	20	40	40	60	70	90
80	100	0	25	25	45	45	70	80	105
100	120	0	25	25	50	50	80	95	120
120	140	0	30	30	60	60	90	105	135
140	160	0	35	35	65	65	100	115	150
160	180	0	35	35	75	75	110	125	165
180	200	0	40	40	80	80	120	140	180
200	225	0	45	45	90	90	135	155	200
225	250	0	50	50	100	100	150	170	215
250	280	0	55	55	110	110	165	185	240
280	315	0	60	60	120	120	180	205	265
315	355	0	65	65	135	135	200	225	295

2 Tapered Bore Bearing Non-interchangeable Clearance

Unit: μm

Nominal bearing bore diameter d (mm)		Tapered bore bearing clearance (non-interchangeable)					
		C9na		C1na		C2na	
Over	Incl.	min	max	min	max	min	max
24	30	5	10	15	25	25	35
30	40	5	12	15	25	25	40
40	50	5	15	17	30	30	45
50	65	5	15	20	35	35	50
65	80	10	20	25	40	40	60
80	100	10	25	35	55	45	70
100	120	10	25	40	60	50	80
120	140	15	30	45	70	60	90
140	160	15	35	50	75	65	100
160	180	15	35	55	85	75	110
180	200	20	40	60	90	80	120
200	225	20	45	60	95	90	135
225	250	25	50	65	100	100	150
250	280	25	55	75	110	110	165
280	315	30	60	80	120	120	180
315	355	30	65	90	135	135	200

6. Lubrication

6-1 Purpose of Lubrication

The main purposes of rolling bearing lubrication is to reduce bearing friction and wear, and to prevent seizure. The appropriate lubrication methods and lubricating agents greatly influences rolling contact bearing performance and service life. The following are the purposes of lubrication.

- ① Lubrication of friction surfaces
 - 1) Reduce rolling friction on roller and raceway surfaces, and reduce sliding friction on roller and guide surfaces in roller bearings
 - 2) Reduce sliding friction between the roller and the cage
 - 3) Reduce sliding friction on cage and raceway ring guide surfaces
- ② Removal of friction-generated heat and heat transmitted from other mechanisms
- ③ Dust-proofing and rust prevention
- ④ Reduce stress concentration
 - 1) Uniform distribution of stress on points or linear contact rolling surfaces.
 - 2) Buffering of impact load

6-2 Lubrication Methods

6.2.1 Oil Lubrication

- ① Forced lubrication (jet lubrication)
 - Forced lubrication is used when cooling is required at relatively high speed rotation or under high ambient temperatures.
 - Jet lubrication supplies vaporized lubricating oil using pressurized oil and a small nozzle, which has a cooling effect.
 - The oil drain port must be larger than the oil supply port because agitation of oil that collects inside the housing increases heat generation and power loss. Particularly with jet lubrication, an oil drain port that is at least 10 times larger than the supply port opposite the nozzle is needed, and a pump should be used for forced draining.
 - Figure 6.1 shows an example of jet lubrication.

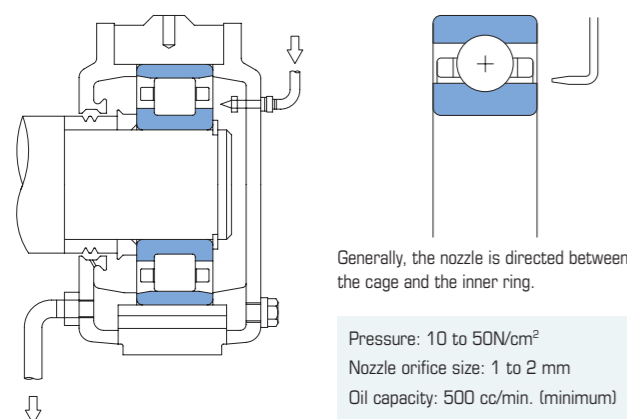

Figure 6.1 Jet Lubrication Example

- ② Vapor lubrication (oil mist lubrication)
 - With this lubrication method, the bearing is air cooled and a small amount of oils required for lubrication is vaporized and sprayed onto the bearing. Figure 6.2 shows an example of oil mist lubrication.
 - Air sent to the mist generator via the pressure adjustor valve is mixed with oil, which is sprayed on the bearing.
 - The nozzle can spray directly onto the bearing, or it can spray onto the bearing using the centrifugal force of the tapered part of a slinger installed on the axis (Figure 6.3).
 - Generally, the mist pressure is 5 to 15 N/cm², with a few cc's of oil mixed with 10 to 50 ℓ/par ts of air every hour.

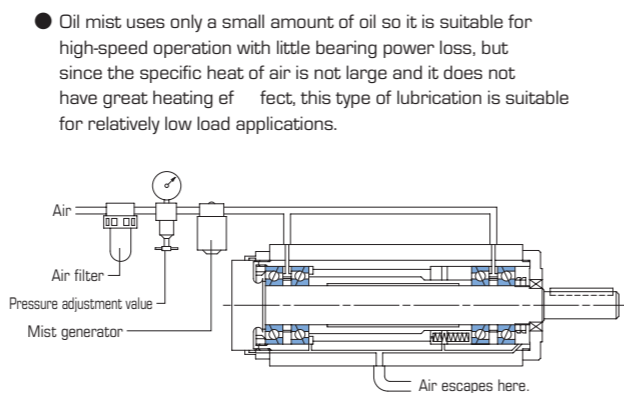

Figure 6.2 Example of Spindle Unit Using Vapor Lubrication

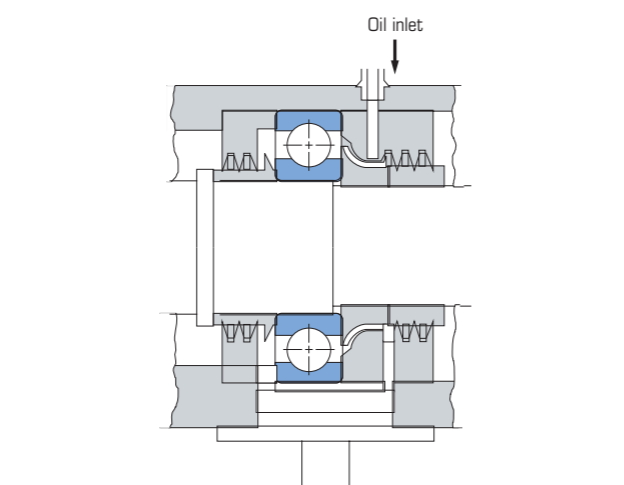

Figure 6.3 Example of Mist Oil Delivery by Slinger

- ③ Oil air lubrication
 - With oil air lubrication, a small amount of lubricating oil is discharged by a measurement piston at fixed intervals, and the lubricating oil is supplied by the mixing valve into compressed air, and then supplied continually to rolling part of the bearing.
 - Since a small and measured amount of new lubricating oil is constantly being supplied, this method is suitable for high-speed applications where little heat is generated.
 - Oil air lubrication is more environmentally friendly because oil requirements are 1/10 that of vapor lubrication and the oil is delivered in the form of droplets rather than a mist.
 - Figure 6.4 shows an example of oil air lubrication.

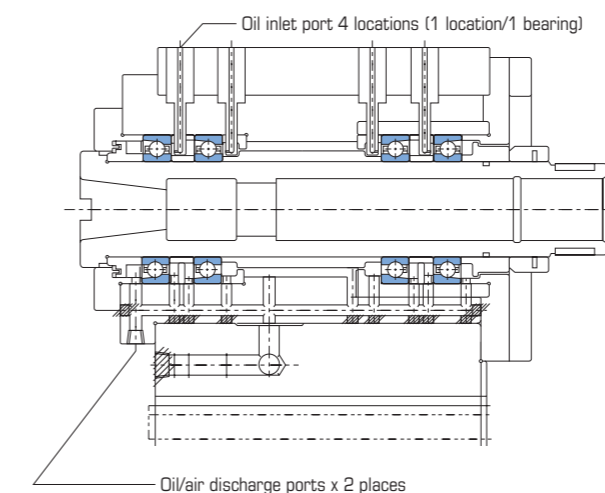

Figure 6.4 Example of Spindle Unit Using Oil Air Lubrication

6.2.2 Grease Lubrication

Note the following precautions whenever using grease lubrication.

- Select the proper grease. For examples of the main types of grease used for machine tool bearings, see Table 6.1.
- Make sure the grease replenishment amount and locations are correct. A greasing amount of 10 to 20% of the bearing internal space volume is recommended for high-speed roller bearings. Note, however, that 40 to 50% is recommended for a ball screw support bearing (open type).
- Over-greasing can result in very high temperatures and large power loss due to agitation. For information about internal space volume of bearings, see Table 6.2 (P.29 to 30).
- For an example illustrating the difference in bearing temperature increase due to lubrication method, see Figure 6.5.

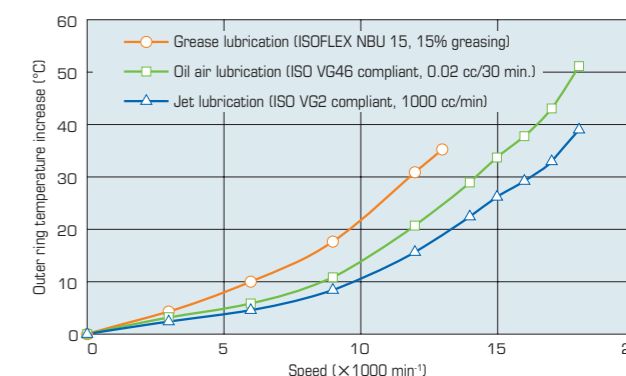

Figure 6.5 Comparison of Temperature Increase Caused by Different Lubrication Methods

Table 6.1 Main Grease Used for Machine Tool Bearings

Grease brand	Manufacturer	Base oil	Thickener	Recommended operation temperature range °C	Main applications
ISOFLEX NBU15	NOK KLUBER	Ester Oil	Barium composite	-40 ~ +130	Spindle bearing
ISOFLEX LDS18 Special A	NOK KLUBER	Ester Oil	Lithium	-60 ~ +130	Spindle bearing
Raremax Super	Kyodo Yushi	Mineral Oil + Synthetic Oil	Urea	-40 ~ +180	Ball Screw Support Bearings
Multemp SB-M	Kyodo Yushi	Synthetic Oil	Diurea	-40 ~ +200	Ball Screw Support Bearings

Lubrication

● Table 6.2 Bearing Internal Space Volume

1 Internal space volume of angular contact ball bearings and cylindrical roller bearings

Unit: cc/each

Bore diameter number	Bore diameter (mm)	Series						
		7900C 7900AC	7000C 7000AC	7200C 7200AC	BNH000	TAH TBH	NN3000	NNU4900
00	10	0.44	0.9	1.2	-	-	-	-
01	12	0.49	1.0	1.7	-	-	-	-
02	15	0.68	1.4	2.2	-	-	-	-
03	17	0.68	1.7	3.0	-	-	-	-
04	20	1.5	2.9	4.7	-	-	-	-
05	25	1.9	3.4	5.3	-	-	3.6	-
06	30	2.2	4.8	8.2	-	-	5.9	-
07	35	3.0	6.4	10.3	5.6	-	7.5	-
08	40	5.2	7.8	13.0	7.2	-	9.5	-
09	45	5.7	10.2	15.4	9.0	-	12.8	-
10	50	6.2	10.7	18.6	9.7	8.0	13.8	-
11	55	-	15.9	25.9	14.0	12.0	19.6	-
12	60	-	17.0	33.2	15.0	13.0	20.7	-
13	65	-	18.2	39.1	16.0	14.0	21.8	-
14	70	-	27.7	45.2	22.0	19.0	30.4	-
15	75	-	28.7	49.4	23.0	20.0	32.9	-
16	80	-	32.1	59.0	30.0	27.0	46.3	-
17	85	-	36.3	73.5	31.0	28.0	47.8	-
18	90	-	49.2	93.1	40.0	38.0	62.9	-
19	95	-	53.0	117	42.0	40.0	64.5	-
20	100	-	55.1	135	43.0	41.0	67.3	49.5
21	105	-	-	-	54.0	52.0	91.8	57.9
22	110	-	-	-	66.0	65.0	114	59.6
24	120	-	-	-	71.0	70.0	126	86.4
26	130	-	-	-	108	105	178	102
28	140	-	-	-	114	111	195	114
30	150	-	-	-	138	139	235	195
32	160	-	-	-	174	167	288	199
34	170	-	-	-	227	225	374	209
36	180	-	-	-	-	-	508	281
38	190	-	-	-	-	-	530	296
40	200	-	-	-	-	-	684	448

2 Ball Screw Support t Bearings (T AB Series) Internal Space Volume

Bearing No.	Internal space volume [cc/ each]
15TAB04	3.8
17TAB04	3.8
20TAB04	3.8
25TAB06	4.8
30TAB06	4.8
35TAB07	5.8
40TAB07	5.8
40TAB09	14
45TAB07	6.5
45TAB10	15
50TAB10	16
55TAB10	16
55TAB12	19
60TAB12	19

3 Ball Screw Support t Bearings (T AF-X Series) Internal Space Volume

Bearing No.	Internal space volume [cc/ each]
25TAF05X	5.3
25TAF06X	9.4
30TAF07X	14
35TAF09X	26
40TAF09X	26
40TAF11X	44
45TAF10X	31
45TAF11X	44
50TAF11X	44
50TAF13X	70
60TAF13X	70
60TAF17X	149
80TAF17X	149
80TAF21X	285
100TAF21X	285
100TAF26X	488
120TAF26X	488

4 Ball Screw Support t Bearings (7001XYS1 Series) Internal Space Volume

Bearing No.	Internal space volume [cc/ each]
7000XYS1	0.8
7001XYS1	0.8
7002XYS1	1.2
7003XYS1	1.7
7004XYS1	2.7

5 Ball Screw Support t Bearings (7200XYS1 Series) Internal Space Volume

Bearing No.	Internal space volume [cc/ each]
7203XYS1	2.6
7204XYS1	4.3
7205XYS1	5.1
7206XYS1	7.8

6.2.3 Grease Life

Grease life is affected by operating temperature, grease type, rotation speed, load, and other factors. Grease life approximate estimates for a rolling contact bearing, which is used as a representative example, can be calculated using Formula 5.1.

$$\log L = -2.3 + \frac{2450}{273 + T} - 0.301 \times (S_G + S_N + S_W) \quad \text{--- (Formula 5.1)}$$

L : Grease life (hours)
 T : Bearing temperature (°C)
 S_G : Life reduction factor based on grease type

Grease type	S _G
Long life petroleum grease and silicon grease	0
Conventional petroleum grease	1.0
Diester and and low temperature grease	2.9

$$S_N = 0.864 \frac{d \cdot n}{(dn)_L}$$

S_N : Life reduction factor based on rotation speed
 d : Nominal bearing bore diameter (mm)
 n : Bearing speed (min⁻¹)
 (dn)_L : Bearing type-specific speed factor

Bearing type	(dn) _L
Angular contact ball bearings	400,000
Cylindrical roller bearings	200,000

$$S_W = 2.714 \frac{n \cdot d \cdot w}{C^2}$$

S_W : Load-specific life reduction factor
 C : Basic dynamic load rating (N)
 w : Bearing load (N)

Technical Description
 Bearing Selection
 Bearing Life
 Bearing Tolerance
 Bearing Arrangement
 Bearing Preload and Rigidity
 Lubrication
 Bearing Mounting Speeds
 Shaft and Housing Design
 Bearing Handling

7. Limiting Speeds

7-1 Limiting Speed Factors

Using a bearing at high speed that exceeds its limit generates frictional heat inside the bearing, which can cause temperatures to rise to levels that will not support bearing performance. The limit on the empirical rotation speed that avoids these problems is called the "Limiting Speed".

The Limiting Speed depends on the bearing type, dimensions, lubricating method, load, etc. The Limiting Speed of a contact seal bearing is limited by the circumferential speed of the contact sections of the seal and raceway ring. The dimension tables in this catalog show

Limiting Speed for grease lubrication and oil lubrication, but these values all assume light load, horizontal shaft operation, and proper lubrication.

Though normally two or more pre-loaded angular contact ball bearings are used, the rotation speed is limited in so it is necessary to multiply the speeds in the dimension tables by the correction factors shown in Table 7.1.

When using a bearing at 75% or more of its Limiting Speed, select the correct required grease type and amount or the correct lubrication oil and method.

Table 7.1 Limiting Speed Factors for Multiple Row Ball Bearing Combinations

No. of bearings in set	E preload (extra-light preload)	L preload (light preload)	M preload (medium preload)	H preload (heavy preload)
2 rows	0.83	0.78	0.63	0.54
3 rows	0.73	0.68	0.54	0.39
4 rows	0.78	0.73	0.59	0.44

8. Shaft and Housing Design

8-1 Shaft and Housing Fits

Appropriate inner ring and shaft fit, and outer ring and housing fit is required in order to get the most performance out of a bearing.

Loose fit surfaces can result in rotation of the raceway rings on the shaft or in the housing.

This is called "creep." When it occurs creep can cause premature failure, vibration, and other trouble due to abnormal heat and wear, from debris getting into the bearing. An interference fit is a good way of preventing creep. For convenient installation the interference fit in on

the inner ring and shaft or on the outer ring and housing (not both).

However, this cannot be done under certain conditions so bearing fitting needs to be determined after carefully considering the relationship between the shaft and housing and other factors.

Recommended fits for general operating conditions (inner ring rotation) of precision bearings used for machine tools are shown in Tables 8.1 through 8.3.

Table 8.1 Shafts and Recommended Fits

Unit: μm

Bearing type	Shaft diameter (mm)		Bearing accuracy class			
			Class 5		Class 4/Class 2	
			Desired fit	Shaft tolerance	Desired fit	Shaft tolerance
Angular contact ball bearings	Over	Incl.				
	10	18	0~2T	h4	0~2T	h3
	18	50	0~2.5T	h4	0~2.5T	h3
	50	80	0~3T	h4	0~3T	h3
	80	150	0~4T	js4	0~4T	js3
Cylindrical roller bearings (cylindrical bore)	150	200	0~5T	js4	0~5T	js3
	25	40	-	js4	-	js4
	40	140	-	k4	-	k3
Main spindle thrust bearing	140	200	-	k4	-	k3
	For all shaft diameters		0~6L	h4	0~6L	h4
Ball screw support bearings	For all shaft diameters		0~10L	h5	0~10L	h5

Table 8.2 Housings and Recommended Fits (Fixed Side)

Unit: μm

Bearing type	Housing bore diameter (mm)		Bearing accuracy class			
			Class 5		Class 4/Class 2	
			Desired fit	Housing bore tolerance	Desired fit	Housing bore tolerance
Angular contact ball bearings	Over	Incl.				
	18	50	0~3L	JS4	0~3L	JS3
	50	120	0~4L	JS4	0~4L	JS3
	120	180	0~5L	JS4	0~5L	JS3
Cylindrical roller bearings	180	250	0~6L	JS4	0~6L	JS3
	Overall housing bore		±0	K5	±0	K5
Main spindle thrust bearing	Overall housing bore		30L~40L	K5	30L~40L	K5
Ball screw support bearings	Overall housing bore		10L~20L	H6	10L~20L	H6

Table 8.3 Housings and Recommended Fits (Free Side)

Unit: μm

Bearing type	Housing bore diameter (mm)		Bearing accuracy class			
			Class 5		Class 4/Class 2	
			Desired fit	Housing bore tolerance	Desired fit	Housing bore tolerance
Angular contact ball bearings	Over	Incl.				
	18	50	6L~10L	H4	6L~10L	H3
	50	120	8L~13L	H4	8L~13L	H3
	120	180	12L~18L	H4	12L~18L	H3
Cylindrical roller bearings	180	250	15L~22L	H4	15L~22L	H3
	Overall housing bore		±0	K5	±0	K4
Ball screw support bearings	Overall housing bore		10L~20L	H6	10L~20L	H6

[Note] In Tables 8.1 through 8.3, "L" following a value indicates loose or clearance fit, while "T" indicates tight or interference fit

8-2 Recommended Accuracy for Shaft and Housing

In order to maintain mechanical performance of the main spindle of a machine tool, the accuracy of installation and of installed components must be equal to or higher than bearing accuracy.

● Table 8.4 Shaft Accuracy Unit: μm

Accuracy item	Shaft diameter		Bearing accuracy class		
	Over	Incl.	Class 5	Class 4	Class 2
Roundness \bigcirc, a	-	10	1.3	0.8	0.5
	10	18	1.5	1.0	0.6
	18	30	2.0	1.3	0.8
	30	50	2.0	1.3	0.8
	50	80	2.5	1.5	1.0
	80	120	3.0	2.0	1.3
	120	180	4.0	2.5	1.8
Cylindricity \diamond, b	-	10	1.3	0.8	0.5
	10	18	1.5	1.0	0.6
	18	30	2.0	1.3	0.8
	30	50	2.0	1.3	0.8
	50	80	2.5	1.5	1.0
	80	120	3.0	2.0	1.3
	120	180	4.0	2.5	1.8
Vibration \nearrow, c	-	10	2.0	2.0	1.3
	10	18	2.5	2.5	1.5
	18	30	3.0	3.0	2.0
	30	50	3.5	3.5	2.0
	50	80	4.0	4.0	2.5
	80	120	5.0	5.0	3.0
	120	180	6.0	6.0	4.0
Concentricity \odot, d	-	10	4.0	4.0	2.5
	10	18	5.0	5.0	3.0
	18	30	6.0	6.0	4.0
	30	50	7.0	7.0	4.0
	50	80	8.0	8.0	5.0
	80	120	10.0	10.0	6.0
	120	180	12.0	12.0	8.0

● Table 8.5 Shaft Fitting Surface Roughness (Ra)

Shaft diameter d	Bearing accuracy class		
	Class 5	Class 4	Class 2
$d \leq 80\text{mm}$	0.2	0.2	0.1
$d > 80\text{mm}$	0.4	0.4	0.2

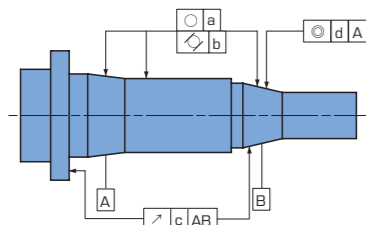

The recommended bearing installation section accuracy and surface roughness are shown in Tables 8.4 to 8.7.

● Table 8.6 Housing Accuracy Unit: μm

Accuracy item	Housing bore diameter		Bearing accuracy class		
	Over	Incl.	Class 5	Class 4	Class 2
Roundness \bigcirc, a_1	-	10	1.3	0.8	0.5
	10	18	1.5	1.0	0.6
	18	30	2.0	1.3	0.8
	30	50	2.0	1.3	0.8
	50	80	2.5	1.5	1.0
	80	120	3.0	2.0	1.3
	120	180	4.0	2.5	1.8
Cylindricity \diamond, b_1	-	10	1.3	0.8	0.5
	10	18	1.5	1.0	0.6
	18	30	2.0	1.3	0.8
	30	50	2.0	1.3	0.8
	50	80	2.5	1.5	1.0
	80	120	3.0	2.0	1.3
	120	180	4.0	2.5	1.8
Vibration \nearrow, c_1	-	10	2.0	2.0	1.3
	10	18	2.5	2.5	1.5
	18	30	3.0	3.0	2.0
	30	50	3.5	3.5	2.0
	50	80	4.0	4.0	2.5
	80	120	5.0	5.0	3.0
	120	180	6.0	6.0	4.0
Concentricity \odot, d_1	-	10	4.0	4.0	2.5
	10	18	5.0	5.0	3.0
	18	30	6.0	6.0	4.0
	30	50	7.0	7.0	4.0
	50	80	8.0	8.0	5.0
	80	120	10.0	10.0	6.0
	120	180	12.0	12.0	8.0

● Table 8.7 Housing Fitting Surface Roughness (Ra)

Housing bore diameter D	Bearing accuracy class		
	Class 5	Class 4	Class 2
$D \leq 80\text{mm}$	0.4	0.4	0.2
$80\text{mm} < D \leq 250\text{mm}$	0.8	0.8	0.4
$D > 250\text{mm}$	1.6	1.6	0.8

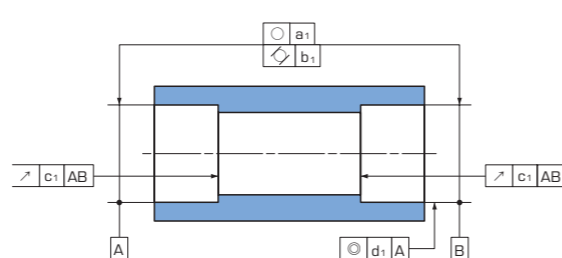

8-3 Chamfer Dimension Limits

● Table 8.8 Chamfer Dimensions for Radial Bearings (Excluding Tapered Roller Bearings) Unit: mm

Smallest permissible chamfer dimensions of inner and outer rings r_{min} or r_1_{min}	Nominal bearing bore diameter		Smallest permissible chamfer dimensions of inner and outer rings r_{max} or r_1_{max}		(Reference) Shaft or housing fillet radius r_a max
	Over	Incl.	Radial direction	Axial direction	
0.05	-	-	0.1	0.2	0.05
0.08	-	-	0.16	0.3	0.08
0.1	-	-	0.2	0.4	0.1
0.15	-	-	0.3	0.6	0.15
0.2	-	-	0.5	0.8	0.2
0.3	-	40	0.6	1	0.3
	40	-	0.8	1	
0.6	-	40	1	2	0.6
	40	-	1.3	2	
1	-	50	1.5	3	1
	50	-	1.9	3	
1.1	-	120	2	3.5	1
	120	-	2.5	4	
1.5	-	120	2.3	4	1.5
	120	-	3	5	
2	-	80	3	4.5	2
	80	220	3.5	5	
2.1	-	280	4	6.5	2
	280	-	4.5	7	
2.5	-	100	3.8	6	2
	100	280	4.5	6	
3	-	280	5	8	2.5
	280	-	5.5	8	
4	-	-	6.5	9	3
5	-	-	8	10	4
6	-	-	10	13	5
7.5	-	-	12.5	17	6
9.5	-	-	15	19	8
12	-	-	18	24	10
15	-	-	21	30	12
19	-	-	25	38	15

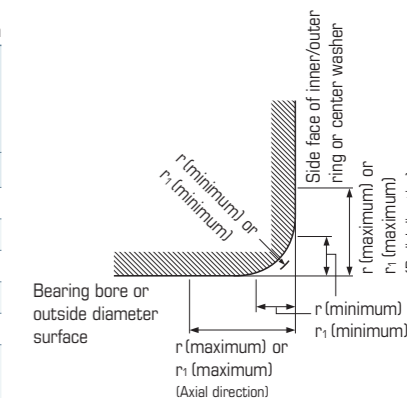

r : Chamfer dimensions of inner ring and outer ring
 r_1 : Chamfer dimensions of inner ring and outer ring (front face etc.) or of center ring of thrust ball bearing

Note ① Exact shape of chamfer is not specified. Limits fall within radial and axial minimum radius and maximum radius.
 ② r (minimum) values in the axial direction of bearings with nominal bearing widths of 2 mm or less r_{max} are the same as those in the radial direction.

9. Bearing Handling

9-1 Storing and Transporting Bearings

Rolling contact bearings are precision components. It is important to handle them with care to avoid damage due to impact. Rolling contact bearings also are susceptible to dirt and rust, so care is required during storage and transportation.

- When storing bearings, select a cool, dry location that is not exposed to direct sunlight or humidity.
- Do not leave bearings on the floor. Store them at a height of at least 30 cm, and avoid exposure to dust.

- First-in, first-out storage should always be used for bearing inventory management. Arrange bearings so those with the oldest packing date can be used first.
- Take care bearings being transported are not crushed or dropped, etc., protect them from damage and deformation due to impact, and ensure they do not become soiled due to broken packing materials.

9-2 Bearing Installation

The quality of bearing installation influences precision, service life, performance, and other factors, so care is required. The following is the procedure for assembly work.

- ① Shaft and housing inspection
- ② Unpacking and cleaning
- ③ Assembly
- ④ Post assembly check

9.2.1 Shaft and Housing Inspection

- Clean the shaft and housing thoroughly and remove any dirt and debris. Also, confirm there are no burrs.
- Confirm that the shaft and housing are finished in accordance with the drawings, and check and record dimensions, shoulder squareness, and the corner radius. As shown in Figure 9.1, measure the shaft diameter and housing bore at two locations in the axial direction and four locations radially.

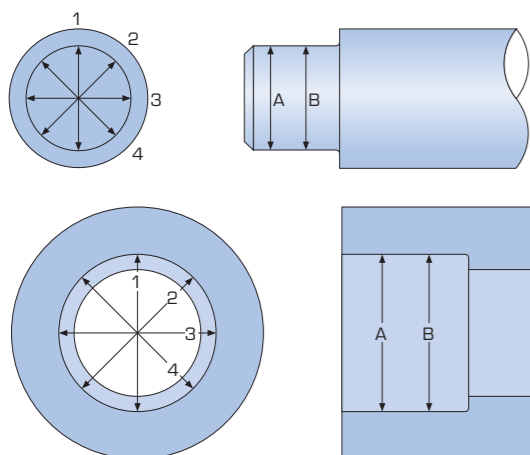

Figure 9.1 Shaft Diameter and Housing Diameter Measurement Locations

9.2.2 Unpacking and Cleaning

- Do not unpack a bearing until just before you are ready to use it. Be sure to wear vinyl gloves when unpacking a bearing. Unpacking a bearing with bare hands or while wearing fabric gloves creates the risk of rust or lint intrusion.
- Apply anti-rust oil to the surface of the unpacked bearing. Wash the bearing with white kerosene. For washing, prepare either a filtered shower or two containers with raised wire mesh bottoms, one for basic washing and one for finish washing.

- After washing, shake the oil from the bearing and then cover it. Do not rotate a bearing that has been degreased.

9.2.3 Mounting

Generally the majority of bearings assembled into machine tools use interference shaft fits and loose housing fits. The method used for mounting bearings to shafts are the shrink and press fits.

Shrink fits

With this mounting method, the bearing is heated until it expands larger than the shaft and the inner ring can be slipped onto the shaft. An electromagnetic heater with degasser (Figure 9.2) avoids undue stress to the inner ring, while an oven helps to shorten process time. Heating temperature must be no greater than 120°C. Temperatures greater than 120°C can decrease bearing hardness and shorten its service life. After a heated bearing is installed on a shaft, it contracts axially as it cools, which can cause a gap between the inner ring and shaft shoulder (Figure 9.3), so positioning is achieved using a nut, etc.

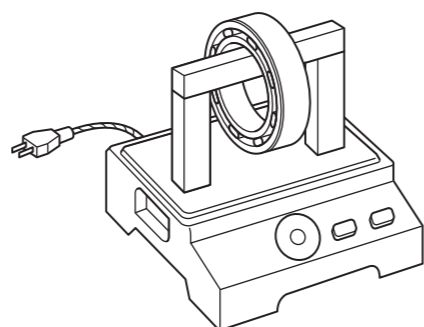

Figure 9.2 Induction Heater

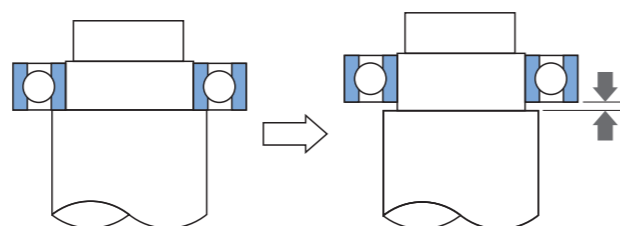

Figure 9.3 Shaft Shoulder Gap After Cooling

Press fits

With this method, a tool is placed on the inner ring side surface and a jack or press is used to press fit (Figure 9.4). When press fitting the inner ring on a shaft do not apply force to the outer ring or cage. In the case of an angular contact ball bearing, application of force in the opposite direction of the contact angle direction should be avoided because it will damage the raceway shoulder (Figure 9.5).

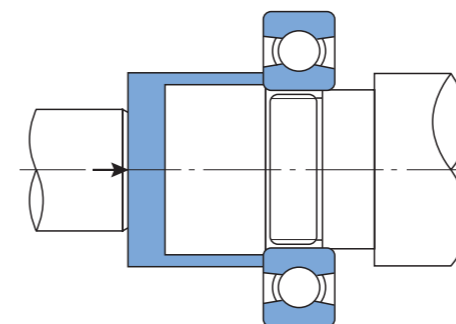

Figure 9.4 Inner Ring Press Fitting

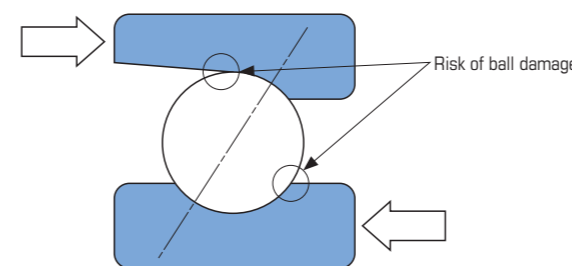

Figure 9.5 Angular Contact Ball Bearing Assembly Direction

Reference: Maximum radial run-out locations

The maximum radial run-out locations of the inner ring and outer ring are indicated by "○" marks on the ring face. Axial run-out can be minimized by aligning the minimum radial run-out location of the axis with the "○" mark on the inner ring. The outer ring also should be assembled so its "○" mark is aligned with the minimum run-out locations of the housing. Note that there is no relationship between the outside ring "○" mark position and the outside diameter " <" mounting mark position.

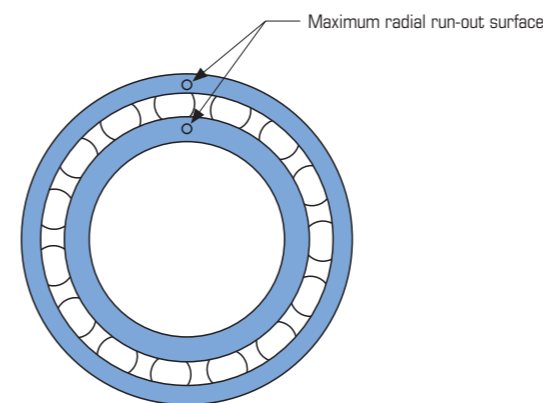

Figure 9.6 Maximum Radial Run-out Locations

Reference: Press fit force and removal force

Though the force required to press fit a bearing inner ring to and removing it from the shaft depends on interference amounts and the shaft surface finish, general values can be obtained using Formula 9.1.

$$K_a = f_k \cdot \Delta d_e \cdot B \cdot \left\{ 1 - \left(\frac{d}{d_i} \right)^2 \right\} \quad \text{--- (Formula 9.1)}$$

- K_a : Press fit force (removal force) [kN]
- f_k : Installation/removal condition coefficient (Table 9.1)
- Δd_e : Effective interference (mm)
- B : Nominal inner ring width (mm)
- d : Nominal bearing bore diameter (mm)
- d_i : Inner ring mean outside diameter (mm)
- Cylindrical roller bearing
 $d_i = (D + 3d) / 4$
- Other bearings
 $d_i = (3D + 7d) / 10$
- Here, D = Nominal bearing outside diameter (mm)

Table 9.1 Installation/Removal Condition Coefficient

Conditions	f_k (mean value)
Inner ring press fit to cylindrical solid shaft	39
Inner ring removal from cylindrical solid shaft	59

[Note] Values when shaft bore and shaft are thinly coated with oil.

Bearing Handling

Mounting on a shaft

Normally a shaft nut is used to secure the inner ring of the bearing to the shaft. It is necessary to ensure that the shaft nut side surface is at the proper angle relative to the thread. If the surfaces are not square tightening of the shaft nut can result in bending of the shaft. Also, adjustment of the shaft nut is required when tightening it because of edge contact due to a gap in the mating surface between the shaft nut and the shaft. Tightening with the shaft nut makes it possible to apply a specific tightening force by controlling the tightening torque. Though there is a discrepancy in the relationship between shaft nut tightening torque and the tightening force due to the accuracy and roughness of each threaded portion, it can be expressed as Formula 9.2. The recommended mounting force for each bearing bore is shown in Table 9.2.

$$F \approx \frac{Mn}{\frac{d_2}{2} \tan(\beta + \rho) + \frac{d_n}{2} \cdot \mu m} \quad \text{(Formula 9.2)}$$

- F : Tightening force (N)
- Mn : Tightening torque (N·mm)
- d₂ : Thread nominal diameter (mm)
- β : Lead angle
- $\tan \beta = \frac{P}{\pi d_2}$
- P : Pitch (mm)
- ρ : Thread surface friction angle
- $\tan \rho = \frac{\mu}{\cos \alpha}$
- α : Half-angle of thread
- d_n : Mean diameter of nut bearing surface (mm)
- μ_m : Coefficient of friction of nut bearing surface (≈ 0.15)
- μ : Coefficient of friction of thread surface (≈ 0.15)

● Table 9.2 Recommended Shaft Nut Tightening Force Values

Nominal bearing bore diameter (mm)	Shaft nut tightening force (N)	Nominal bearing bore diameter (mm)	Shaft nut tightening force (N)
10	1,500	80	19,600
12	2,500	85	19,600
15	2,500	90	19,600
17	2,500	95	19,600
20	4,900	100	19,600
25	4,900	105	19,600
30	4,900	110	19,600
35	4,900	120	19,600
40	9,800	130	19,600
45	9,800	140	29,400
50	9,800	150	29,400
55	14,700	160	29,400
60	14,700	170	29,400
65	14,700	180	29,400
70	14,700	190	29,400
75	14,700	200	29,400

Mounting on a housing

In order to secure the outer ring of a bearing in the axial direction, clearing normally is maintained between the press-fit cover and housing and a bolt is used for tightening. Caution is required because outer ring misalignment and deformation can occur bolts are not tightened correctly or uniformly (Figure 9.7). Generally an Outer Ring Clearance Reduction Gap Δ of 0.010 to 0.020 is recommended. Recommended Clearance Reduction Gap Values for a face-to-face ball support bearing (T AB Series, TAF-X Series) are shown in Tables 9.3 and 9.4.

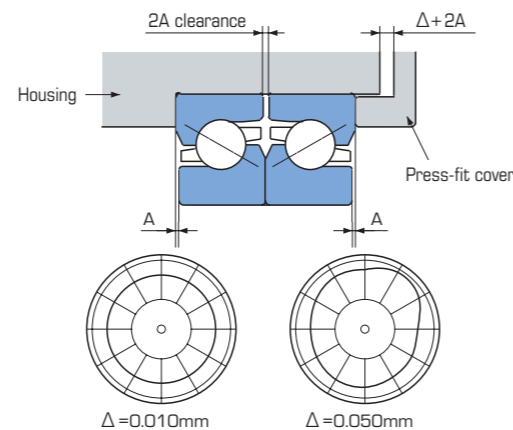

Figure 9.7 Example of Raceway Deflection Depending on Outer Ring Clearance Reduction Gap

● Table 9.3 Recommended Clearance Reduction Gap Values for Ball Screw Support Bearings (T AB Series)

Bearing No.	External ring clearance reduction gap Δ (mm)
15TAB04 DF	0.010 ~ 0.030
17TAB04 DF	
20TAB04 DF	
25TAB06 DF	0.010 ~ 0.040
30TAB06 DF	
35TAB07 DF	
40TAB07 DF	
40TAB09 DF	0.020 ~ 0.050
45TAB07 DF	
45TAB10 DF	
50TAB10 DF	
55TAB10 DF	
55TAB12 DF	
60TAB12 DF	0.020 ~ 0.060

● Table 9.4 Recommended Clearance Reduction Gap Values for Ball Screw Support Bearings (T AF-X Series)

Bearing No.	External ring clearance reduction gap Δ (mm)
25TAF06X DF	0.020
30TAF07X DF	
35TAF09X DF	
40TAF09X DF	0.030
40TAF11X DF	
45TAF11X DF	
50TAF11X DF	
60TAF13X DF	
60TAF17X DF	
80TAF17X DF	0.040
100TAF21X DF	
120TAF03X DF	

Tapered bore cylindrical roller bearing clearance adjustment

- The internal clearance of a tapered bore cylindrical roller bearing can be adjusted by the spacer width using the procedure below.
- Check the shaft taper. Coat the taper with a thin layer of bluing; 80% or more contact is required.
 - Lightly place the inner sub-unit onto the shaft taper (Figure 9.8).
 - Place the outer ring and fix the shaft horizontally.
 - Touch the center of the outer ring with a dial gauge probe.
 - Pressing down on the outer ring from above, rotate it left and right a few times so it fits well, and then zero set the dial gauge.
 - Push the outer ring straight up 180° from its position of symmetry (directly below), and rotate it slightly left and right to take a reading of its maximum value (Figure 9.9).
 - Change the position of the shaft at steps of approximately 30°, measure the axial displacement, and calculate the average of the readings as the value of D R.
 - Use a block gauge to measure the length to the inner ring edges surface and shaft shoulder (Figure 9.10).
 - Change the position and use the average of five or six locations as the value for L'.
 - Use Formula 9.3 to determine the wide dimension of the required spacer.

$$L = L' - 12 (\Delta R - \Delta - \lambda e \cdot \delta) \quad \text{(Formula 9.3)}$$

- L' : Average spacer width obtained in step ⑨
- ΔR : Measured radial clearance
- Δ : Desired post-assembly radial clearance
- λe : External ring contraction ratio

$$\lambda e = \frac{D_e}{D} - \frac{1 - \left(\frac{D}{D_h}\right)^2}{1 - \left(\frac{D_e}{D_h}\right)^2}$$

- D : Inner ring outside diameter (mm)
- D_e : Inner ring bore (mm)
- D_h : Housing bore (mm)
- δ : Outer ring interference

- Correct the spacer width dimension.
- Remove the inner sub-unit from the shaft. This time avoid striking the inner ring with strong force. Use of a special removal tool to make ring removal easy.
- Install the spacer and bearing onto the shaft.
- Again, measure the radial clearance and confirm that the desired radial clearance is provided (Figure 9.11).

9.2.4 Post Assembly Check

Use the procedure under "5-3 Measuring Preload" (Part 17) to confirm that the prescribed preload is being applied.

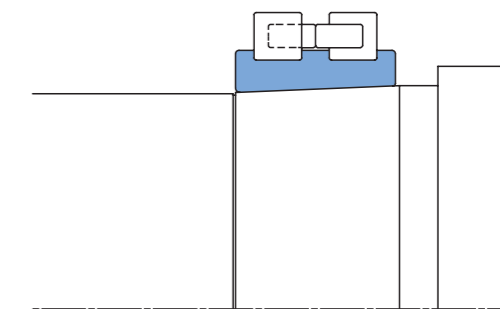

Figure 9.8 Inner Sub-unit Temporary Tightening

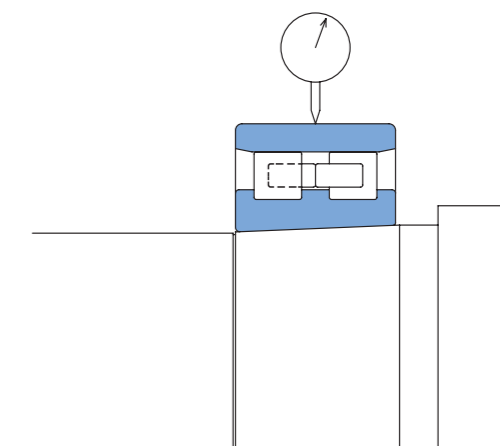

Figure 9.9 Radial Clearance Measurement

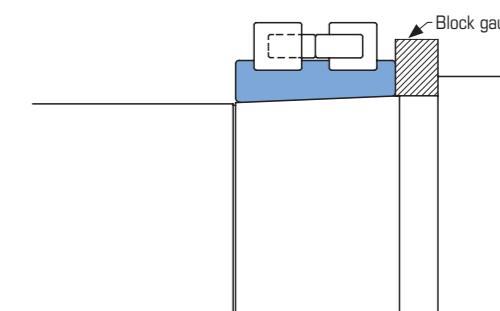

Figure 9.10 Spacer Temporary Width Dimension Measurement

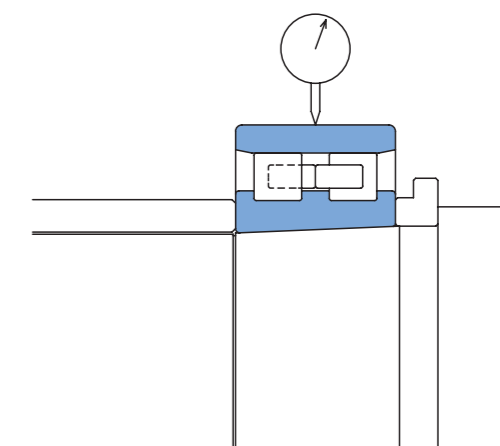

Figure 9.11 Final Assembly Radial Clearance Check

9-3 Running Test

After installing bearings, a test run is performed to confirm that operation is normal. Particularly when using grease lubrication the grease must be given time to distribute evenly within the bearings, and sufficient running-in time is required. The following is the general running test procedure.

- ① Check to make sure there is no gap between the shaft and housing or the cover or that all the gaps are uniform.
- ② First rotate manually any rotatable mechanisms and check for abnormal noise and sticking.
- ③ For large mechanisms that cannot be rotated manually start at a speed that is as low as possible then do the same checks as step ② while coasting.

- ④ If no abnormalities are discovered during the first three steps above, gradually increase speed up to normal operating speed while confirming that the rise in temperature is within normal conditions.
- ⑤ For long term operation, check for bolt and nut looseness, oil and grease leaks, and abnormal noise. If possible, after completing the test run drain the lubricant and check for the presence of foreign matter.
- ⑥ Actual operation can be started after completing the run in test.

9-4 Removing Bearings

Though the main reasons for removing bearings is periodic maintenance and mechanical breakdown, it also should be used as an opportunity to check the current status of a machine and to use what is learned for improvements, etc. Particularly in the case of malfunction, the key reasons for the breakdown usually can be found after disassembly. Because of this, the following points should be checked when removing bearings.

- ① Problems with bearing installation
- ② Insufficient lubricating oil or grease, and the amount of contaminants present (Collect samples.)

- ③ Inner ring and outer ring fitting
 - ④ Bearing trouble
- The following items also need to be settled before starting bearing removal.
- ① Bearing removal method
 - ② Fitting conditions
 - ③ Tools required for removal

Dimension Tables

Dimension Tables

Types and Designs

7900/7000/7200

BNH

TAH/TBH

NN3000/NNU4900

XRN/XRG

TAB/T AU/T AF-X/XY91/W1

Precision Rolling Bearing Types and Designs

Type	Cross section	Bearing series	Contact angle	Description
Angular contact ball bearings		7900C	15°	<ul style="list-style-type: none"> ■ Balls and the inner ring and outer ring raceways are designed for contact in a specific contact angle, which means this type of bearing is suitable for composite loads (axial load and radial load). ■ The contact angle means that axial force components are generated when a radial load is applied, so these bearings are normally used in pairs at either end of a shaft. ■ A contact angle of 15° is best for high speed, while a contact angle of 25° is better for axial loads.
		7900AC	25°	
		7000C	15°	
		7000AC	25°	
		7200C	15°	
		7200AC	25°	
High-speed angular contact ball bearings		BNH	15°	<ul style="list-style-type: none"> ■ Since ball slipping is reduced by the gyro-moment at high-speeds, the ball diameter of this type of bearing is smaller than that of a standard angular contact ball bearing. ■ This type of bearing is dimensionally interchangeable with the 7000 Series, and can be used for their replacement.
Thrust load angular contact ball bearings		TAH	30°	<ul style="list-style-type: none"> ■ The contact angle of this type is smaller than that of the previous TAD Series (double-direction thrust angular contact ball bearings), for less gyro-moment induced ball sliding and lower temperature. ■ Can be used to replace TAD Series bearings.
		TBH	40°	
NN type double row cylindrical roller bearings		NN3000	-	<ul style="list-style-type: none"> ■ Increased number of rollers to achieve higher rigidity. ■ Tapered bore allows adjustment of the internal clearance. ■ Oil groove and oil hole in the center of outer ring are also available.
NNU type double row cylindrical roller bearings		NNU4900	-	
Cross tapered roller bearings		XRN XRG	-	<ul style="list-style-type: none"> ■ Designed as an alternate to tapered roller bearings, this series provides high axial load and moment load rigidity. ■ Rollers have rotational and orbital centers for smooth rotation.
Ball screw support bearings		TAB	60°	<ul style="list-style-type: none"> ■ Mainly used in machine tool ball screw support applications. ■ Open type and sealed type (contact type, non-contact type) available.
		TAU	60°	<ul style="list-style-type: none"> ■ Housing and outer ring are integrated to achieve easy maintenance and to be more compact. ■ Contact seal is standard design.
		TAF-X	55°	<ul style="list-style-type: none"> ■ Mainly used for ball screw support application for electric injection molding machine. ■ Large diameter balls and large contact angles for high axial load carrying capacity.
		XYS1	30°	<ul style="list-style-type: none"> ■ Higher load capacity and axial limiting load in the same dimension as conventional 70 and 72 series angular contact bearings. ■ Compatible design with 70 and 72 series angular contact bearings.
W1Y		30°	<ul style="list-style-type: none"> ■ Nachi proprietary seal provides high sealing ability and dust resistance. ■ Quiet operation due to polyamide cage and high performance grease. 	



Angular Contact Ball Bearings

Standard Type



Nomenclature of Bearing Numbers

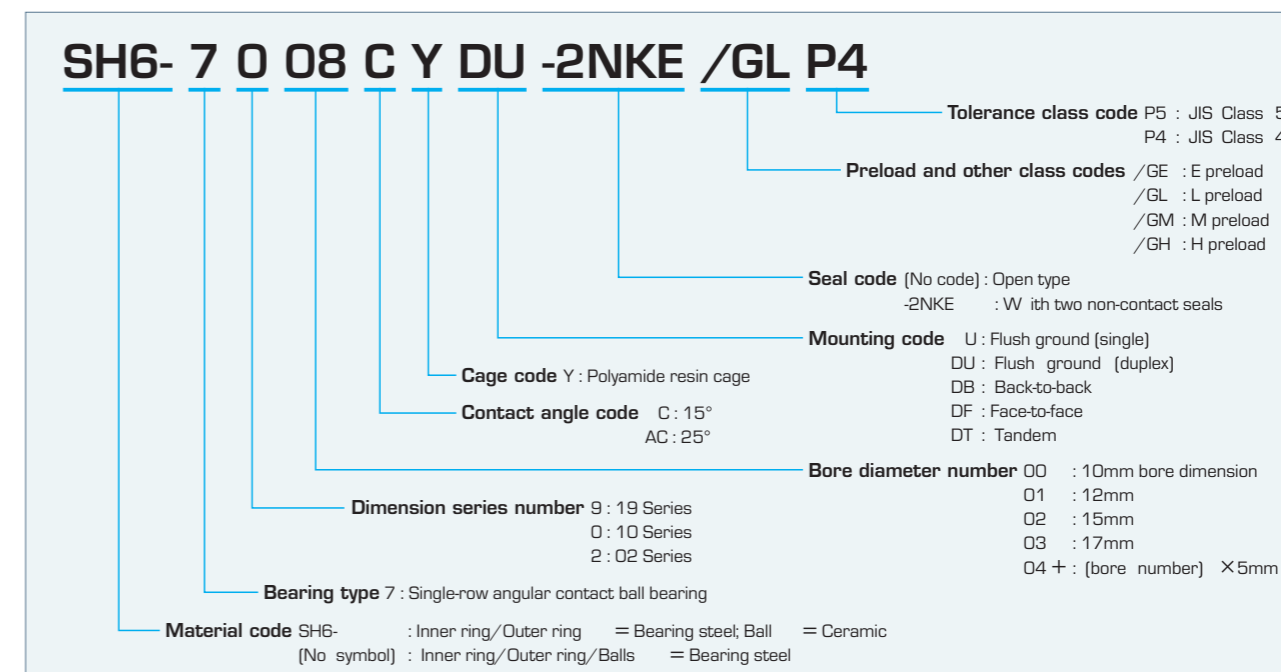

Features

- With angular contact ball bearings, the balls and the inner ring and outer ring are in a single configuration, axial load is limited to a single direction, this type of bearing is suitable for bearing composite loads made up of axial and radial loads.
- Since this type of bearing has a contact angle, axial components are generated when a radial load is applied. Because of this, this type of bearing is normally used in pairs at either end of a shaft.
- Ceramic ball type also available.

Contact Angle

- Two contact angles are available: 15° and 25°.
- 15° is for high-speed applications.
- 25° is for applications requiring high axial rigidity.

Cage

- A ball guide polyamide cage is provided as standard.
- The polyamide cage should be used under temperatures lower than 120°.

Dimensional Accuracy, Rotational Accuracy

Conforms to JIS Class 5 or Class 4. See page 10 for details.

Preload

- Four types of standard preload settings are available. Use the table below to select the preload that meets your criteria.
- See page 19 through 21 for standard preloads available for each series and size.

Preload Selection Criteria

Preload code	Selection criteria
E preload	Prevents mechanical vibration and increases accuracy.
L preload	Provides rigidity at high-speed (dmn value = 500,000) operation.
M preload	Provides higher than L preload rigidity at standard-speed operation.
H preload	Provides maximum rigidity at low-speed operation.

Mounting

See page 15 and 16 for multiple-row arrangements.

ing raceways form a specific angle of contact. When used in a single configuration, axial load is limited to a single direction, this type of bearing is suitable for bearing composite loads made up of axial and radial loads.

ated when a radial load is applied. Because of this, this type of bearing is normally used in pairs at either end of a shaft.

Ceramic Ball Types

Bearings with ceramic balls that are less dense than bearing steel balls also are available for lower centrifugal force when balls rotate at high speeds.

- The characteristics of ceramic and bearing steel are shown in the table below.
- The bearing number of a bearing that uses ceramic balls starts with "SH6".
- Preload and axial rigidity is approximately 1.2 times that of bearing steel type bearings.

Comparison of Ceramic and Bearing Steel Characteristics

Features	Unit	Ceramic (Si ₃ N ₄)	Bearing steels (SUJ2)
Heat resistance	°C	800	180
Density	g/cc	3.2	7.8
Linear expansion coefficient	1/°C	3.2 × 10 ⁻⁶	12.5 × 10 ⁻⁶
Hardness	Hv	1,400 ~ 1,700	700 ~ 800
Longitudinal elastic coefficient	GPa	314	206
Poisson's ratio	-	0.26	0.30
Corrosion resistance	-	Good	No good
Magnetism	-	Non-magnetic substance	Strongly magnetic substance
Conductivity	-	Insulator	Conductor
Crystal chemical bonding	-	Covalent	Metallic

Types with Seals

- The 70 Series also has bearings with non-contact seals suitable for high speed.

Angular Contact Ball Bearings

7900C Series
7900AC Series

Contact angle $\alpha=15^\circ$

Contact angle $\alpha=25^\circ$

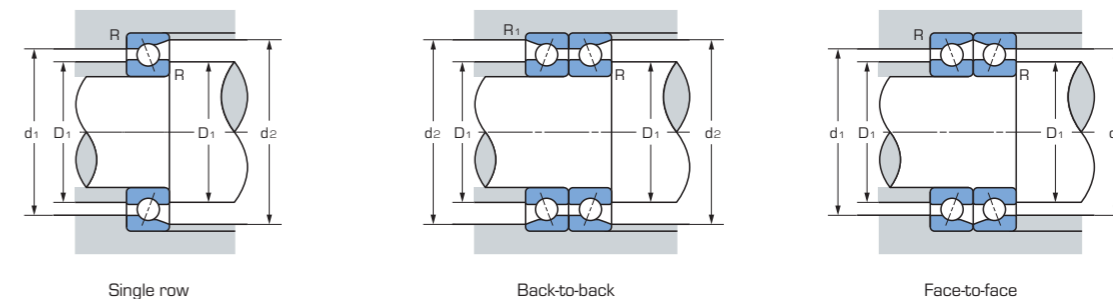
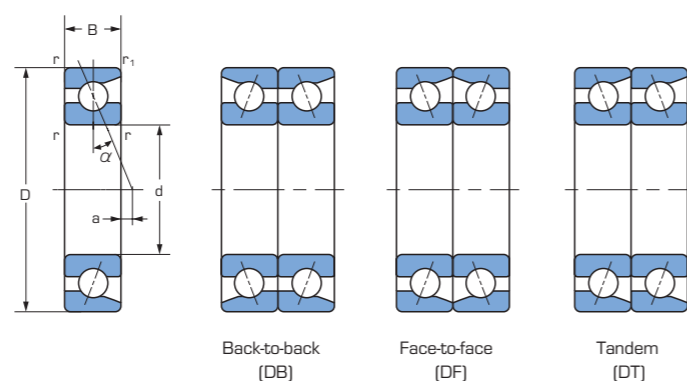

Bearing No.	Boundary dimensions (mm)					Load center a (mm)	Basic dynamic load rating Cr (kN)	Basic static load rating Cor (kN)	Limiting speed (min ⁻¹)		Corner radius (mm)					Mass (kg) (Reference)	Bearing No.
	d	D	B	r _{min}	r _{1 min}				Grease lubrication	Oil lubrication	D _{1 min}	d _{1 max}	d _{2 max}	R _{max}	R _{1 max}		
7900C	10	22	6	0.3	0.15	-0.9	3.00	1.52	73,000	100,000	12.5	19.5	20.8	0.3	0.15	0.008	7900C
7900AC	10	22	6	0.3	0.15	0.7	2.88	1.45	63,500	85,000	12.5	19.5	20.8	0.3	0.15	0.008	7900AC
7901C	12	24	6	0.3	0.15	-0.6	3.20	1.72	64,800	88,800	14.5	21.5	22.8	0.3	0.15	0.010	7901C
7901AC	12	24	6	0.3	0.15	1.2	3.05	1.63	56,400	75,500	14.5	21.5	22.8	0.3	0.15	0.010	7901AC
7902C	15	28	7	0.3	0.15	-0.6	4.75	2.64	54,300	74,400	17.5	25.5	26.8	0.3	0.15	0.015	7902C
7902AC	15	28	7	0.3	0.15	1.5	4.55	2.53	47,200	63,200	17.5	25.5	26.8	0.3	0.15	0.015	7902AC
7903C	17	30	7	0.3	0.15	-0.3	5.00	2.95	49,700	68,000	19.5	27.5	28.8	0.3	0.15	0.016	7903C
7903AC	17	30	7	0.3	0.15	2.1	4.75	2.82	43,200	57,800	19.5	27.5	28.8	0.3	0.15	0.016	7903AC
7904C	20	37	9	0.3	0.15	-0.7	7.30	4.55	41,000	56,100	22.5	34.5	35.8	0.3	0.15	0.035	7904C
7904AC	20	37	9	0.3	0.15	2.1	6.95	4.35	35,600	47,700	22.5	34.5	35.8	0.3	0.15	0.035	7904AC
7905C	25	42	9	0.3	0.15	0.1	7.80	5.45	34,800	47,700	27.5	39.5	40.8	0.3	0.15	0.041	7905C
7905AC	25	42	9	0.3	0.15	3.5	7.40	5.15	30,300	40,600	27.5	39.5	40.8	0.3	0.15	0.041	7905AC
7906C	30	47	9	0.3	0.15	0.7	8.30	6.25	30,300	41,500	32.5	44.5	45.8	0.3	0.15	0.046	7906C
7906AC	30	47	9	0.3	0.15	4.5	7.85	5.95	26,300	35,300	32.5	44.5	45.8	0.3	0.15	0.046	7906AC
7907C	35	55	10	0.6	0.3	1.0	12.5	9.65	25,900	35,500	39.5	50.5	52.5	0.6	0.3	0.074	7907C
7907AC	35	55	10	0.6	0.3	5.5	11.9	9.20	22,500	30,200	39.5	50.5	52.5	0.6	0.3	0.074	7907AC
7908C	40	62	12	0.6	0.3	0.8	15.7	12.4	22,900	31,300	44.5	57.5	59.5	0.6	0.3	0.107	7908C
7908AC	40	62	12	0.6	0.3	5.9	14.9	11.8	19,900	26,600	44.5	57.5	59.5	0.6	0.3	0.107	7908AC
7909C	45	68	12	0.6	0.3	1.6	16.6	14.1	20,600	28,300	49.5	63.5	65.5	0.6	0.3	0.127	7909C
7909AC	45	68	12	0.6	0.3	7.2	15.7	13.3	18,000	24,000	49.5	63.5	65.5	0.6	0.3	0.127	7909AC
7910C	50	72	12	0.6	0.3	2.2	17.7	15.5	19,100	26,200	54.5	67.5	69.5	0.6	0.3	0.128	7910C
7910AC	50	72	12	0.6	0.3	8.2	16.4	14.9	16,600	22,300	54.5	67.5	69.5	0.6	0.3	0.128	7910AC

Angular Contact Ball Bearings

7000C Series
7000AC Series

Contact angle $\alpha=15^\circ$
Contact angle $\alpha=25^\circ$

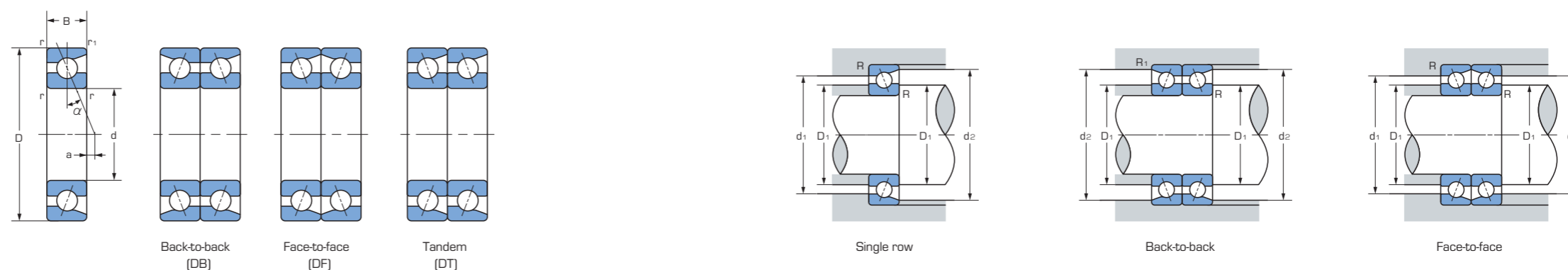

Bearing No.	Boundary dimensions (mm)					Load center a (mm)	Basic dynamic load rating C_r (kN)	Basic static load rating C_{or} (kN)	Limiting speed (min ⁻¹)		Corner radius (mm)					Mass (kg) (Reference)	Bearing No.
	d	D	B	r_{min}	r_{1min}				Grease lubrication	Oil lubrication	D_{1min}	d_{1max}	d_{2max}	R_{max}	R_{1max}		
7000C	10	26	8	0.3	0.15	-1.9	5.35	2.50	65,000	89,000	12	24	25	0.3	0.15	0.022	7000C
7000AC	10	26	8	0.3	0.15	0.2	5.15	2.41	56,500	75,500	12	24	25	0.3	0.15	0.022	7000AC
7001C	12	28	8	0.3	0.15	-1.7	5.80	2.91	58,500	80,000	14	26	27	0.3	0.15	0.024	7001C
7001AC	12	28	8	0.3	0.15	0.7	5.60	2.79	51,000	68,000	14	26	27	0.3	0.15	0.026	7001AC
7002C	15	32	9	0.3	0.15	-1.8	6.65	3.70	49,500	68,000	17	30	31	0.3	0.15	0.035	7002C
7002AC	15	32	9	0.3	0.15	1.0	6.30	3.55	43,000	58,000	17	30	31	0.3	0.15	0.035	7002AC
7003C	17	35	10	0.3	0.15	-2.0	7.00	4.15	45,000	61,500	19	33	34	0.3	0.15	0.045	7003C
7003AC	17	35	10	0.3	0.15	1.1	6.65	3.95	39,000	52,500	19	33	34	0.3	0.15	0.045	7003AC
7004C	20	42	12	0.6	0.3	-2.4	11.2	6.60	37,500	51,500	24	38	40	0.6	0.3	0.079	7004C
7004AC	20	42	12	0.6	0.3	1.2	10.6	6.25	32,500	44,000	24	38	40	0.6	0.3	0.079	7004AC
7005C	25	47	12	0.6	0.3	-1.8	12.9	8.65	32,500	44,500	29	43	45	0.6	0.3	0.091	7005C
7005AC	25	47	12	0.6	0.3	2.4	11.7	7.60	28,200	37,500	29	43	45	0.6	0.3	0.091	7005AC
7006C	30	55	13	1	0.6	-1.6	16.0	11.1	27,400	37,500	35	50	52	1	0.6	0.135	7006C
7006AC	30	55	13	1	0.6	3.4	15.1	10.5	23,900	32,000	35	50	52	1	0.6	0.135	7006AC
7007C	35	62	14	1	0.6	-1.4	19.3	13.7	24,100	33,000	40	57	59	1	0.6	0.170	7007C
7007AC	35	62	14	1	0.6	4.3	18.2	13.0	21,000	28,000	40	57	59	1	0.6	0.170	7007AC
7008C	40	68	15	1	0.6	-1.3	20.7	16.0	21,600	29,600	45	63	65	1	0.6	0.210	7008C
7008AC	40	68	15	1	0.6	5.1	19.5	15.1	18,800	25,200	45	63	65	1	0.6	0.210	7008AC
7009C	45	75	16	1	0.6	-1.1	24.6	19.4	19,500	26,700	50	70	72	1	0.6	0.265	7009C
7009AC	45	75	16	1	0.6	6.0	23.1	18.3	16,900	22,700	50	70	72	1	0.6	0.265	7009AC
7010C	50	80	16	1	0.6	-0.5	26.2	22.0	18,000	24,600	55	75	77	1	0.6	0.285	7010C
7010AC	50	80	16	1	0.6	7.2	23.7	19.7	15,600	20,900	55	75	77	1	0.6	0.285	7010AC
7011C	55	90	18	1.1	0.6	-0.6	34.5	28.8	16,100	22,100	61	84	86	1	0.6	0.420	7011C
7011AC	55	90	18	1.1	0.6	7.9	31.0	25.6	14,000	18,800	61	84	86	1	0.6	0.420	7011AC
7012C	60	95	18	1.1	0.6	-0.1	35.5	30.5	15,000	20,600	66	89	91	1	0.6	0.450	7012C
7012AC	60	95	18	1.1	0.6	9.1	32.0	27.6	13,100	17,500	66	89	91	1	0.6	0.450	7012AC
7013C	65	100	18	1.1	0.6	0.5	37.5	34.5	14,200	19,400	71	94	96	1	0.6	0.470	7013C
7013AC	65	100	18	1.1	0.6	10.2	34.0	31.0	12,300	16,500	71	94	96	1	0.6	0.470	7013AC
7014C	70	110	20	1.1	0.6	0.4	47.0	43.0	13,000	17,800	76	104	106	1	0.6	0.660	7014C
7014AC	70	110	20	1.1	0.6	11.0	44.5	41.0	11,300	15,100	76	104	106	1	0.6	0.660	7014AC
7015C	75	115	20	1.1	0.6	1.0	48.5	46.0	12,300	16,800	81	109	111	1	0.6	0.695	7015C
7015AC	75	115	20	1.1	0.6	12.2	45.5	43.0	10,700	14,300	81	109	111	1	0.6	0.695	7015AC
7016C	80	125	22	1.1	0.6	0.8	59.0	55.5	11,400	15,600	86	119	121	1	0.6	0.925	7016C
7016AC	80	125	22	1.1	0.6	12.9	55.5	52.5	9,900	13,300	86	119	121	1	0.6	0.925	7016AC
7017C	85	130	22	1.1	0.6	1.4	60.5	59.0	10,900	14,900	91	124	126	1	0.6	0.960	7017C
7017AC	85	130	22	1.1	0.6	14.1	57.0	55.5	9,400	12,700	91	124	126	1	0.6	0.960	7017AC
7018C	90	140	24	1.5	1	1.3	72.0	69.5	10,100	13,900	97	133	135.6	1.5	1	1.26	7018C
7018AC	90	140	24	1.5	1	14.8	68.0	65.5	8,800	11,800	97	133	135.6	1.5	1	1.26	7018AC
7019C	95	145	24	1.5	1	1.9	74.0	73.5	9,700	13,300	102	138	140.6	1.5	1	1.36	7019C
7019AC	95	145	24	1.5	1	16.0	69.5	69.5	8,400	11,300	102	138	140.6	1.5	1	1.36	7019AC
7020C	100	150	24	1.5	1	2.4	76.0	77.5	9,300	12,800	107	143	145.6	1.5	1	1.37	7020C
7020AC	100	150	24	1.5	1	17.2	71.0	73.0	8,100	10,900	107	143	145.6	1.5	1	1.37	7020AC

Angular Contact Ball Bearings

7200C Series
7200AC Series

Contact angle $\alpha=15^\circ$
Contact angle $\alpha=25^\circ$

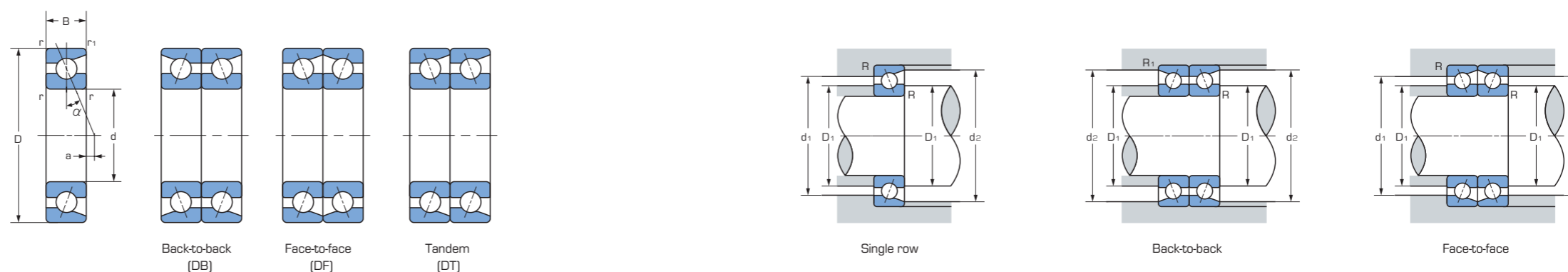

Bearing No.	Boundary dimensions (mm)					Load center a (mm)	Basic dynamic load rating C_r (kN)	Basic static load rating C_{or} (kN)	Limiting speed (min ⁻¹)		Corner radius (mm)					Mass (kg) (Reference)	Bearing No.
	d	D	B	r_{min}	r_{1min}				Grease lubrication	Oil lubrication	D_{1min}	d_{1max}	d_{2max}	R_{max}	R_{1max}		
7200C	10	30	9	0.6	0.3	-2.2	6.95	3.30	58,500	80,000	15	25	27.4	0.6	0.3	0.034	7200C
7200AC	10	30	9	0.6	0.3	0.2	6.75	3.20	51,000	68,000	15	25	27.4	0.6	0.3	0.034	7200AC
7201C	12	32	10	0.6	0.3	-2.5	7.95	3.90	53,000	72,500	17	27	29.4	0.6	0.3	0.040	7201C
7201AC	12	32	10	0.6	0.3	0.2	7.65	3.75	46,000	62,000	17	27	29.4	0.6	0.3	0.040	7201AC
7202C	15	35	11	0.6	0.3	-2.6	8.70	4.55	46,500	64,000	20	30	32.4	0.6	0.3	0.048	7202C
7202AC	15	35	11	0.6	0.3	0.4	8.35	4.40	40,500	54,500	20	30	32.4	0.6	0.3	0.048	7202AC
7203C	17	40	12	0.6	0.3	-2.7	10.9	5.90	41,000	56,000	22	35	37.4	0.6	0.3	0.070	7203C
7203AC	17	40	12	0.6	0.3	0.8	10.5	5.65	35,500	47,500	22	35	37.4	0.6	0.3	0.070	7203AC
7204C	20	47	14	1	0.6	-3.1	14.7	8.15	34,500	47,500	26	41	43.4	1	0.6	0.110	7204C
7204AC	20	47	14	1	0.6	0.9	14.0	7.80	30,500	40,500	26	41	43.4	1	0.6	0.110	7204AC
7205C	25	52	15	1	0.6	-3.1	16.7	10.3	30,000	41,500	31	46	48.4	1	0.6	0.135	7205C
7205AC	25	52	15	1	0.6	1.6	15.9	9.80	26,400	35,500	31	46	48.4	1	0.6	0.135	7205AC
7206C	30	62	16	1	0.6	-2.7	23.2	14.9	25,200	34,500	36	56	58.4	1	0.6	0.210	7206C
7206AC	30	62	16	1	0.6	2.8	22.0	14.1	22,000	29,600	36	56	58.4	1	0.6	0.210	7206AC
7207C	35	72	17	1.1	0.6	-2.3	30.5	20.1	21,800	29,900	42	65	67	1	0.6	0.295	7207C
7207AC	35	72	17	1.1	0.6	4	29.1	19.1	19,000	25,400	42	65	67	1	0.6	0.295	7207AC
7208C	40	80	18	1.1	0.6	-2.1	36.5	25.4	19,500	26,700	47	73	75	1	0.6	0.380	7208C
7208AC	40	80	18	1.1	0.6	5	34.5	24.1	16,900	22,700	47	73	75	1	0.6	0.380	7208AC
7209C	45	85	19	1.1	0.6	-2.0	41.0	29.0	18,000	24,600	52	78	80	1	0.6	0.430	7209C
7209AC	45	85	19	1.1	0.6	5.7	39.0	27.5	15,600	20,900	52	78	80	1	0.6	0.430	7209AC
7210C	50	90	20	1.1	0.6	-1.9	43.0	32.0	16,700	22,900	57	83	85	1	0.6	0.485	7210C
7210AC	50	90	20	1.1	0.6	6.3	41.0	30.5	14,500	19,400	57	83	85	1	0.6	0.485	7210AC
7211C	55	100	21	1.5	1	-1.6	53.0	40.0	15,000	20,600	64	91	94.6	1.5	1	0.635	7211C
7211AC	55	100	21	1.5	1	7.6	50.5	38.0	13,100	17,500	64	91	94.6	1.5	1	0.635	7211AC
7212C	60	110	22	1.5	1	-1.2	64.5	49.5	13,700	18,800	69	101	104.6	1.5	1	0.820	7212C
7212AC	60	110	22	1.5	1	8.8	58.0	43.5	12,000	16,000	69	101	104.6	1.5	1	0.820	7212AC
7213C	65	120	23	1.5	1	-0.8	73.5	59.0	12,600	17,300	74	111	114.6	1.5	1	1.02	7213C
7213AC	65	120	23	1.5	1	10.1	66.5	52.0	11,000	14,700	74	111	114.6	1.5	1	1.02	7213AC
7214C	70	125	24	1.5	1	-0.7	80.0	65.0	12,000	16,400	79	116	119.6	1.5	0.8	1.12	7214C
7214AC	70	125	24	1.5	1	10.7	72.5	57.5	10,400	13,900	79	116	119.6	1.5	0.8	1.12	7214AC
7215C	75	130	25	1.5	1	-0.7	83.5	70.0	11,400	15,600	84	121	124.6	1.5	1	1.23	7215C
7215AC	75	130	25	1.5	1	11.4	75.5	62.5	9,900	13,300	84	121	124.6	1.5	1	1.23	7215AC
7216C	80	140	26	2	1	-0.3	93.5	78.0	10,600	14,500	90	130	134	2	1	1.50	7216C
7216AC	80	140	26	2	1	12.7	88.5	74.0	9,200	12,400	90	130	134	2	1	1.50	7216AC
7217C	85	150	28	2	1	-0.4	100	85.0	9,900	13,600	95	140	144	2	1	1.87	7217C
7217AC	85	150	28	2	1	13.4	95.0	81.0	8,600	11,600	95	140	144	2	1	1.87	7217AC
7218C	90	160	30	2	1	-0.6	124	105	9,300	12,800	100	150	154	2	1	2.30	7218C
7218AC	90	160	30	2	1	14.2	112	93.0	8,100	10,900	100	150	154	2	1	2.30	7218AC
7219C	95	170	32	2.1	1.1	-0.7	133	115	8,800	12,100	107	158	163	2	1	2.78	7219C
7219AC	95	170	32	2.1	1.1	14.9	126	107	7,700	10,300	107	158	163	2	1	2.78	7219AC
7220C	100	180	34	2.1	1.1	-0.8	150	128	8,300	11,400	112	168	173	2	1	3.32	7220C
7220AC	100	180	34	2.1	1.1	15.7	142	121	7,200	9,700	112	168	173	2	1	3.32	7220AC

High-speed Angular Contact Ball Bearings

BNH Series



Nomenclature of Bearing Numbers

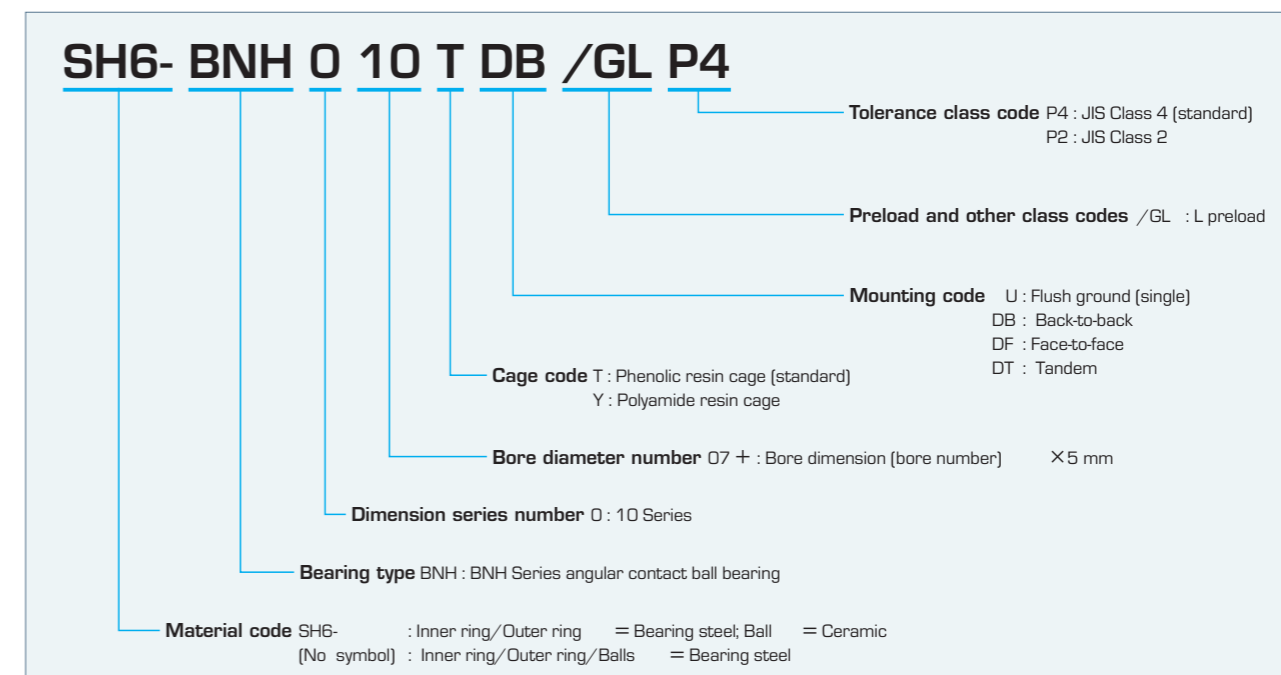

Features

- Smaller machine steel balls, higher speeds, and lower temperatures than previous angular contact ball bearings. Mainly used for the main spindle of high-speed machining centers.
- Ceramic ball type also available.

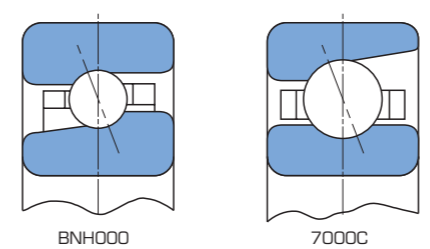

Contact Angle

15° contact angle provided as standard.

Cage

Outer ring guided phenolic resin cage provided as standard. Ball guide polyamide resin cage also available.

Dimensional Accuracy, Rotational Accuracy

JIS Class 4 compliance as standard. See page 10 for details.

Preload

L preload as standard. See page 22 for information about preloads.

Ceramic Ball Types

- Bearings with ceramic balls that are less dense than bearing steel balls also are available for lower centrifugal force when balls rotate at high speeds.
- The characteristics of ceramic and bearing steel are shown in the table below.
- The bearing numbers of bearings that use ceramic balls start with "SH6-".
- Preload and axial rigidity is approximately 1.2 times that of bearing steel type bearings.

Comparison of Ceramic and Bearing Steel Characteristics

Features	Unit	Ceramic (Si ₃ N ₄)	Bearing steels (SUJ2)
Heat resistance	°C	800	180
Density	g/cc	3.2	7.8
Linear expansion coefficient	1/°C	3.2 × 10 ⁻⁶	12.5 × 10 ⁻⁶
Hardness	Hv	1,400 ~ 1,700	700 ~ 800
Longitudinal elastic coefficient	GPa	314	206
Poisson's ratio	-	0.26	0.30
Corrosion resistance	-	Good	No good
Magnetism	-	Non-magnetic substance	Strongly magnetic substance
Conductivity	-	Insulator	Conductor
Crystal chemical bonding	-	Covalent	Metallic

Dimension Tables
 Types and Designs
 7900/7000/7200
 BNH
 TAH/TBH
 NN3000/NU4900
 XRN/XRG
 TAB/TAU/TAFX/XYS1/W1

High-speed Angular Contact Ball Bearings

BNH Series

Contact angle $\alpha = 15^\circ$

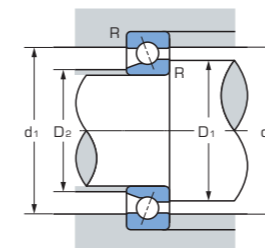
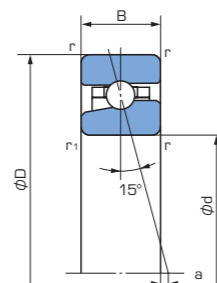

Single-row or tandem

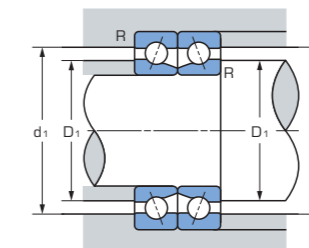

Back-to-back

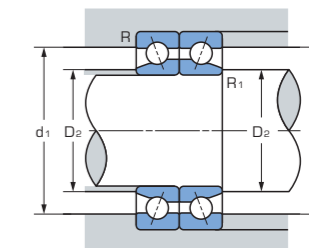

Face-to-face

Bearing No.	Boundary dimensions (mm)					Load center a (mm)	Basic dynamic load rating Cr (kN)	Basic static load rating Cor (kN)	Limiting speed (min ⁻¹)		Corner radius (mm)					Mass (kg) (Reference)	Bearing No.
	d	D	B	r _{min}	r _{1 min}				Grease lubrication	Oil lubrication	D _{1 min}	D _{2 min}	d _{1 max}	R _{max}	R _{1 max}		
BNH007	35	62	14	1	0.6	-0.5	11.6	9.95	28,900	39,000	40	39	57	1	0.6	0.167	BNH007
BNH008	40	68	15	1	0.6	-0.3	14.8	12.9	26,000	35,000	45	44	63	1	0.6	0.200	BNH008
BNH009	45	75	16	1	0.6	0	15.5	14.5	23,400	31,500	50	49.5	70	1	0.6	0.260	BNH009
BNH010	50	80	16	1	0.6	0.7	16.1	15.9	21,600	29,200	55	54.5	75	1	0.6	0.280	BNH010
BNH011	55	90	18	1.1	0.6	0.7	20.0	20.1	19,400	26,200	61	59.5	84	1	0.6	0.400	BNH011
BNH012	60	95	18	1.1	0.6	1.4	20.8	21.9	18,100	24,500	66	64.5	89	1	0.6	0.433	BNH012
BNH013	65	100	18	1.1	0.6	2.1	21.5	23.4	17,000	23,000	71	69.5	94	1	0.6	0.460	BNH013
BNH014	70	110	20	1.1	0.6	2.1	29.4	31.5	15,600	21,100	76	74.5	104	1	0.6	0.650	BNH014
BNH015	75	115	20	1.1	0.6	2.7	29.8	32.5	14,800	20,000	81	79.5	109	1	0.6	0.690	BNH015
BNH016	80	125	22	1.1	0.6	2.7	35.0	39.0	13,700	18,500	86	84.5	119	1	0.6	0.930	BNH016
BNH017	85	130	22	1.1	0.6	3.4	35.5	40.0	13,100	17,700	91	89.5	124	1	0.6	0.973	BNH017
BNH018	90	140	24	1.5	1	3.4	46.5	53.0	12,200	16,500	97	95.5	133	1.5	1	1.27	BNH018
BNH019	95	145	24	1.5	1	4.1	47.0	55.0	11,700	15,800	102	100.5	138	1.5	1	1.33	BNH019
BNH020	100	150	24	1.5	1	4.7	48.0	56.5	11,200	15,200	107	105.5	143	1.5	1	1.39	BNH020
BNH021	105	160	26	2	1	4.8	54.5	65.0	10,600	14,300	115	110.5	150	2	1	1.77	BNH021
BNH022	110	170	28	2	1	4.8	61.0	74.0	10,000	13,600	120	115.5	160	2	1	2.18	BNH022
BNH024	120	180	28	2	1	6.1	63.0	79.0	9,400	12,700	130	125.5	170	2	1	2.32	BNH024
BNH026	130	200	33	2	1	5.6	83.5	105	8,500	11,500	140	135.5	190	2	1	3.46	BNH026
BNH028	140	210	33	2	1	6.9	86.0	112	8,000	10,900	150	145.5	200	2	1	3.68	BNH028
BNH030	150	225	35	2.1	1.1	7.6	102	132	7,500	10,100	161	156	213	2	1	4.55	BNH030
BNH032	160	240	38	2.1	1.1	7.8	110	145	7,000	9,500	172	166	228	2	1	5.57	BNH032
BNH034	170	260	42	2.1	1.1	7.8	129	173	6,500	8,800	182	176	248	2	1	7.50	BNH034

Thrust Load Angular Contact Ball Bearings

TAH/TBH Series



Nomenclature of Bearing Numbers

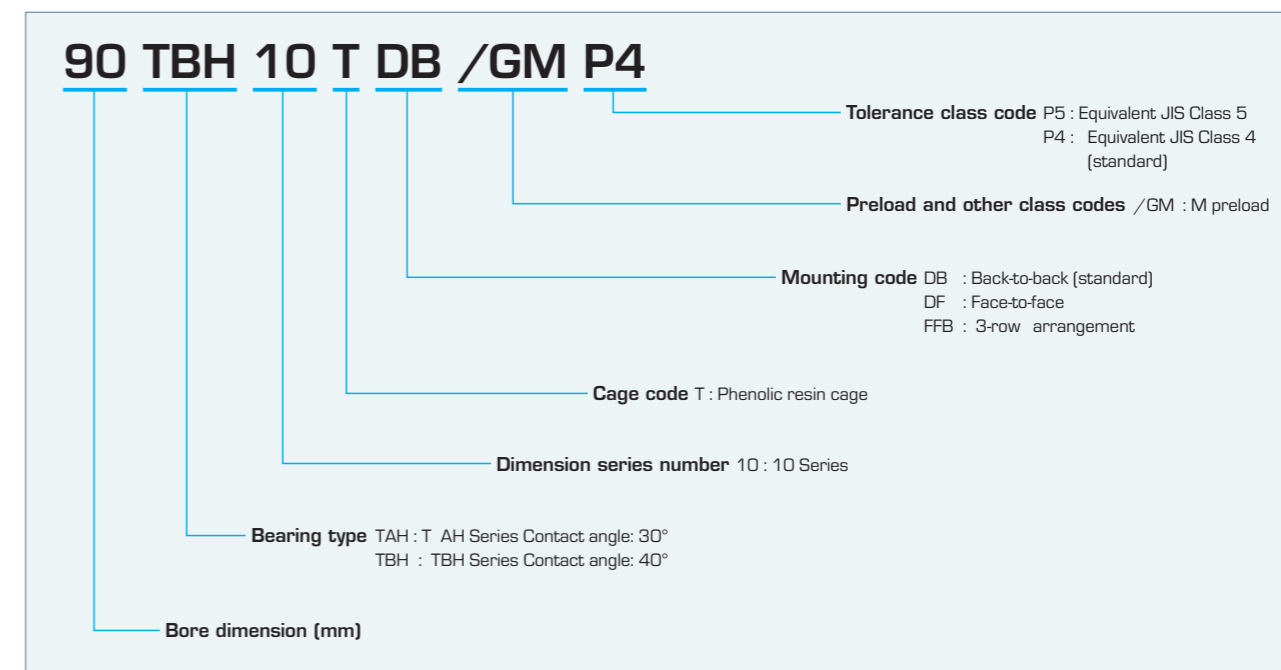

Features

- Same number and diameter of balls as the T AD20 type double-direction thrust angular contact ball bearings, and with smaller contact angles, 30° (T AH Series) or 40° (TBH Series), providing better high-speed performance with no separable ring.
- 2B width dimension of a duplex mounting (DB or DF) that is equivalent to the B1 dimension of the T AD20 T type. T AH/TBH Series are interchangeable by changing the method used to secure them to the shaft.

Contact Angle

30° contact angle for the T AH Series, 40° contact angle for the TBH Series.

Cage

Outer ring guided phenolic resin cage provided as standard.

Dimensional Accuracy, Rotational Accuracy

Equivalent JIS Class 4 compliance as standard, but the external ring outside diameter has smaller tolerances compared to the jointly used radial bearing. See page 12 for details.

Preload

M preload as standard. See page 22 for information about preloads.

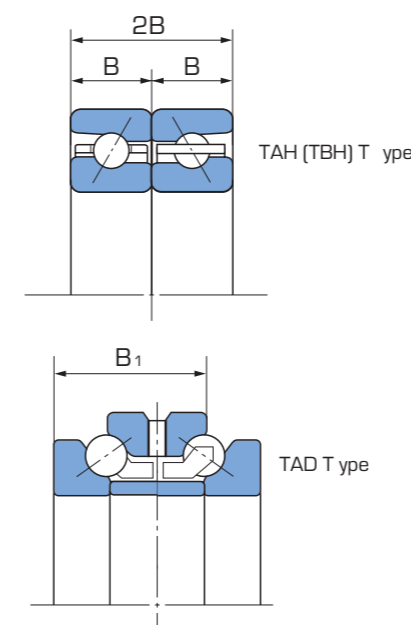

Thrust Load Angular Contact Ball Bearings

TAH Series

Contact angle $\alpha = 30^\circ$

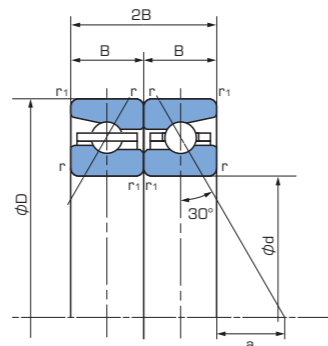

1N=0.102kgf

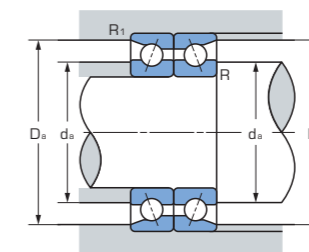

Bearing No.	Boundary dimensions (mm)					Load center a (mm)	Basic dynamic load rating Ca (kN)	Basic static load rating Coa (kN)	Limiting speed (min ⁻¹)		Corner radius (mm)				Mass (kg) (Reference)	Bearing No.
	d	D	2B	r _{min}	r _{1min}				Grease lubrication	Oil lubrication	da _{min}	Da _{max}	R _{min}	R _{1min}		
50TAH10DB	50	80	28.5	1	0.6	11.6	19.2	40.5	11,500	14,600	61	75	1	0.6	0.266	50TAH10DB
55TAH10DB	55	90	33	1.1	0.6	12.7	23.8	51.0	10,300	13,100	68	84	1	0.6	0.405	55TAH10DB
60TAH10DB	60	95	33	1.1	0.6	14.1	24.7	56.0	9,700	12,300	73	89	1	0.6	0.432	60TAH10DB
65TAH10DB	65	100	33	1.1	0.6	15.6	25.6	61.0	9,100	11,500	78	94	1	0.6	0.460	65TAH10DB
70TAH10DB	70	110	36	1.1	0.6	17.0	35.0	80.0	8,300	10,600	85	104	1	0.6	0.622	70TAH10DB
75TAH10DB	75	115	36	1.1	0.6	18.4	35.5	83.5	7,900	10,000	90	109	1	0.6	0.655	75TAH10DB
80TAH10DB	80	125	40.5	1.1	0.6	19.5	41.5	99.5	7,300	9,200	97	118	1	0.6	0.900	80TAH10DB
85TAH10DB	85	130	40.5	1.1	0.6	20.9	42.0	104	7,000	8,800	102	123	1	0.6	0.944	85TAH10DB
90TAH10DB	90	140	45	1.5	1	21.9	55.5	135	6,500	8,200	107.5	132	1.5	1	1.24	90TAH10DB
95TAH10DB	95	145	45	1.5	1	23.4	56.0	141	6,200	7,900	112.5	137	1.5	1	1.30	95TAH10DB
100TAH10DB	100	150	45	1.5	1	24.8	57.0	147	6,000	7,600	117.5	142	1.5	1	1.35	100TAH10DB
105TAH10DB	105	160	49.5	2	1	25.9	64.5	168	5,600	7,100	125	151	2	1	1.75	105TAH10DB
110TAH10DB	110	170	54	2	1	26.9	73.0	191	5,300	6,800	132	160	2	1	2.20	110TAH10DB
120TAH10DB	120	180	54	2	1	29.8	75.0	207	5,000	6,300	142	170	2	1	2.36	120TAH10DB
130TAH10DB	130	200	63	2	1	31.9	99.5	269	4,500	5,700	156	188	2	1	3.52	130TAH10DB
140TAH10DB	140	210	63	2	1	34.8	103	291	4,200	5,400	166	198	2	1	3.75	140TAH10DB
150TAH10DB	150	225	67.5	2.1	1.1	37.3	121	340	4,000	5,000	178	212	2	1	4.59	150TAH10DB
160TAH10DB	160	240	72	2.1	1.1	39.7	131	375	3,700	4,700	190	227	2	1	5.62	160TAH10DB
170TAH10DB	170	260	81	2.1	1.1	41.8	154	445	3,400	4,400	204	245	2	1	7.63	170TAH10DB

Thrust Load Angular Contact Ball Bearings

TBH Series

Contact angle $\alpha = 40^\circ$

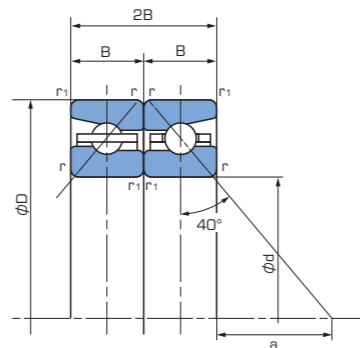

1N=0.102kgf

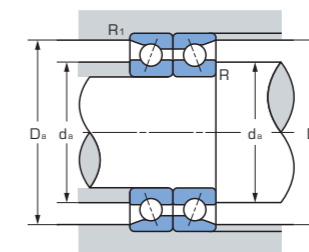

Bearing No.	Boundary dimensions (mm)					Load center a (mm)	Basic dynamic load rating Ca (kN)	Basic static load rating Coa (kN)	Limiting speed (min ⁻¹)		Corner radius (mm)				Mass (kg) (Reference)	Bearing No.
	d	D	2B	r _{min}	r _{1min}				Grease lubrication	Oil lubrication	da _{min}	Da _{max}	R _{min}	R _{1min}		
50TBH10DB	50	80	28.5	1	0.6	20.2	22.8	53.0	10,000	13,200	61	75	1	0.6	0.266	50TBH10DB
55TBH10DB	55	90	33	1.1	0.6	22.2	28.2	67.0	8,900	11,800	68	84	1	0.6	0.405	55TBH10DB
60TBH10DB	60	95	33	1.1	0.6	24.3	29.3	73.0	8,300	11,000	73	89	1	0.6	0.432	60TBH10DB
65TBH10DB	65	100	33	1.1	0.6	26.4	30.0	79.5	7,900	10,400	78	94	1	0.6	0.460	65TBH10DB
70TBH10DB	70	110	36	1.1	0.6	28.8	41.5	104	7,200	9,500	85	104	1	0.6	0.622	70TBH10DB
75TBH10DB	75	115	36	1.1	0.6	30.9	42.0	109	6,800	9,000	90	109	1	0.6	0.655	75TBH10DB
80TBH10DB	80	125	40.5	1.1	0.6	32.9	49.0	130	6,300	8,300	97	118	1	0.6	0.900	80TBH10DB
85TBH10DB	85	130	40.5	1.1	0.6	35.0	50.0	136	6,000	7,900	102	123	1	0.6	0.944	85TBH10DB
90TBH10DB	90	140	45	1.5	1	37.0	65.5	176	5,600	7,400	107.5	132	1.5	1	1.24	90TBH10DB
95TBH10DB	95	145	45	1.5	1	39.1	66.5	184	5,400	7,100	112.5	137	1.5	1	1.30	95TBH10DB
100TBH10DB	100	150	45	1.5	1	41.2	67.5	191	5,200	6,800	117.5	142	1.5	1	1.35	100TBH10DB
105TBH10DB	105	160	49.5	2	1	43.2	76.5	219	4,900	6,400	125	151	2	1	1.75	105TBH10DB
110TBH10DB	110	170	54	2	1	45.3	86.0	249	4,600	6,100	132	160	2	1	2.20	110TBH10DB
120TBH10DB	120	180	54	2	1	49.5	88.5	269	4,300	5,700	142	170	2	1	2.36	120TBH10DB
130TBH10DB	130	200	63	2	1	53.5	118	350	3,900	5,200	156	188	2	1	3.52	130TBH10DB
140TBH10DB	140	210	63	2	1	57.7	121	380	3,700	4,900	166	198	2	1	3.75	140TBH10DB
150TBH10DB	150	225	67.5	2.1	1.1	61.8	143	445	3,400	4,500	178	212	2	1	4.59	150TBH10DB
160TBH10DB	160	240	72	2.1	1.1	65.9	155	490	3,200	4,200	190	227	2	1	5.62	160TBH10DB
170TBH10DB	170	260	81	2.1	1.1	70.0	182	580	3,000	3,900	204	245	2	1	7.63	170TBH10DB

Dimension Tables

Types and Designs

7900/7000/7200

BNH

TAH/TBH

NN3000/NUU4900

XRN/XRG

TAB/TAU/TAFX/XYS1/W1

Double row Cylindrical Roller Bearings

NN3000/NNU4900 Series



Nomenclature of Bearing Numbers

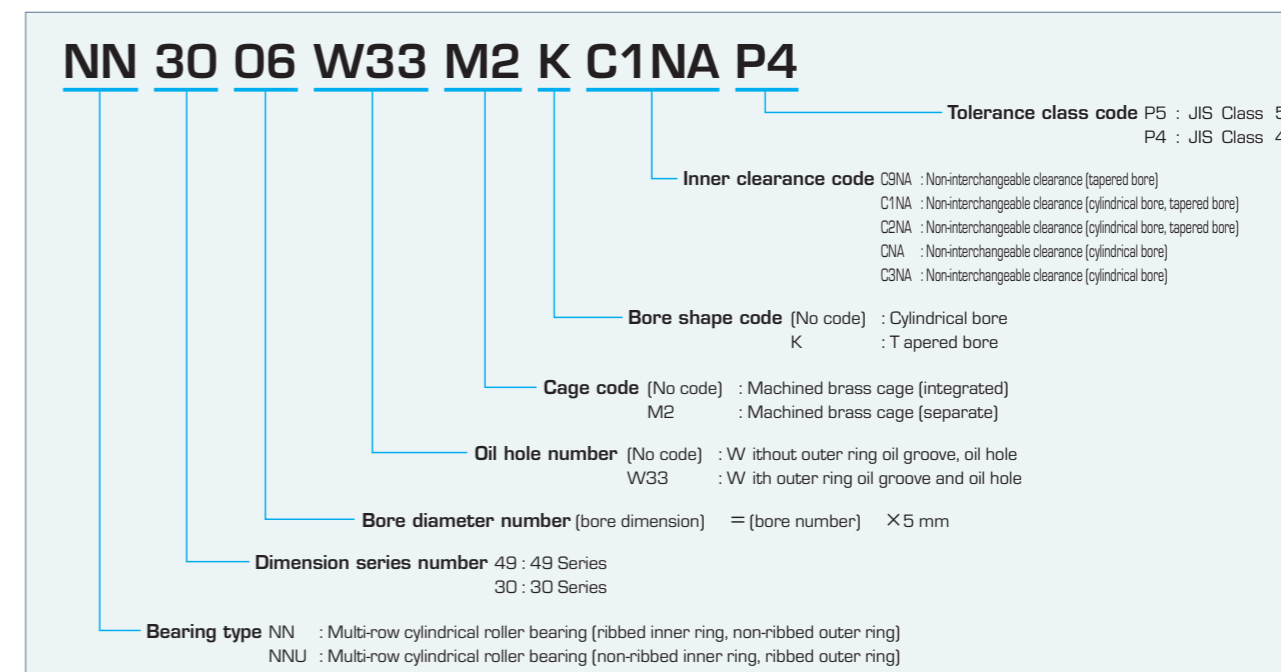

Features

- Simple design providing high accuracy . Increased number of rollers achieve higher rigidity .
- Achieve lower heat generation than a tapered roller bearing due to less sliding friction.
- Tapered bore allows radial internal clearance to be adjusted after mounting.
- This bearing cannot accept axial load so normally it is used together with a thrust bearing.

Cage

Both the NN3000 Series and NNU4900 Series are provided with brass alloy roller guide cage as standard.

Dimensional Accuracy, Rotational Accuracy

- Conforms to JIS Class 5 or Class 4. See page 10 for details.
- Nachi defines its own tolerance values for accuracy of dimensions. See page 14 for details.

Radial Internal Clearance

Nachi defines its own non-interchangeable clearances for cylindrical bores and tapered bores in order to minimize axial run-out inconsistency . See page 26 for details.

Outer Ring Oil Hole Dimensions

The table below shows the dimensions of the outer ring oil hole and oil groove (W33 Specification)

Outer ring width dimension B (mm)		Oil hole diameter dH (mm)	Oil groove width A (mm)
Over	Incl.		
-	19	2	3.5
19	25	2	4
25	35	3	6
35	50	4	8
50	80	6	10
80	-	8	12

Nominal outside diameter dimensions D (mm)		Number of oil holes N
Over	Incl.	
-	250	4
250	-	6

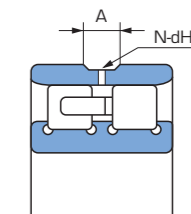

Dimension Tables
 Types and Designs
 7900/7000/7200
 BNH
 TAB/TBH
 NN3000/NNU4900
 XRN/XRG
 TAB/TAU/TAFX/XYS1/W1

Double row Cylindrical Roller Bearings

NN3000 Series

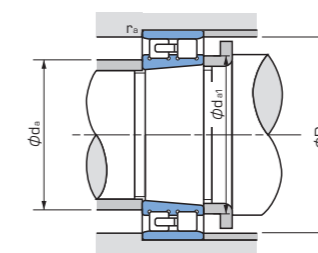
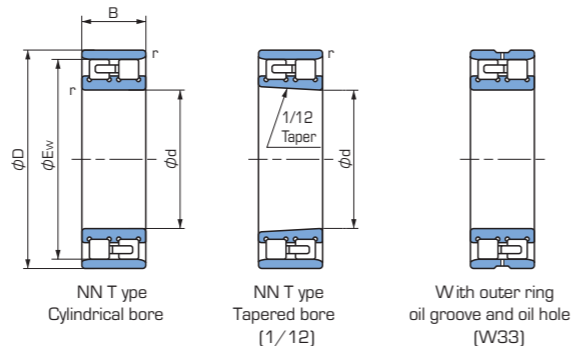

Bearing No.		Boundary dimensions (mm)					Basic dynamic load rating Cr (kN)	Basic static load rating Cor (kN)	Limiting speed (min ⁻¹)		Corner radius (mm)				Mass (kg) (Reference) (Tapered bore)	Bearing No. (Tapered bore)	
Cylindrical bore	Tapered bore	d	D	B	E _w	r _{min}			Grease lubrication	Oil lubrication	da _{min}	da _{1min}	Da				ra _{max}
											max	min					
NN3005	NN3005K	25	47	16	41.3	0.6	25.8	30.0	21,300	25,000	30	30	42	41.8	0.6	0.123	NN3005K
NN3006	NN3006K	30	55	19	48.5	1	31.0	37.0	18,000	21,200	36	37	49	49	1	0.199	NN3006K
NN3007	NN3007K	35	62	20	55	1	39.5	50.0	15,800	18,600	41	42	56	56	1	0.258	NN3007K
NN3008	NN3008K	40	68	21	61	1	43.5	55.5	14,200	16,700	46	48	62	62	1	0.312	NN3008K
NN3009	NN3009K	45	75	23	67.5	1	52.0	65.5	12,800	15,000	51	52	69	69	1	0.405	NN3009K
NN3010	NN3010K	50	80	23	72.5	1	53.0	72.5	11,700	13,800	56	58	74	74	1	0.454	NN3010K
NN3011	NN3011K	55	90	26	81	1.1	69.5	96.5	10,500	12,400	62	64	83	82	1	0.651	NN3011K
NN3012	NN3012K	60	95	26	86.1	1.1	73.5	106	9,800	11,600	67	68	88	87	1	0.704	NN3012K
NN3013	NN3013K	65	100	26	91	1.1	77.0	116	9,200	10,900	72	74	93	92	1	0.758	NN3013K
NN3014	NN3014K	70	110	30	100	1.1	97.5	148	8,500	10,000	77	78	103	101	1	1.04	NN3014K
NN3015	NN3015K	75	115	30	105	1.1	96.5	149	8,000	9,400	82	84	108	106	1	1.14	NN3015K
NN3016	NN3016K	80	125	34	113	1.1	119	186	7,500	8,800	87	90	118	114	1	1.52	NN3016K
NN3017	NN3017K	85	130	34	118	1.1	125	201	7,100	8,300	92	96	123	119	1	1.61	NN3017K
NN3018	NN3018K	90	140	37	127	1.5	143	228	6,600	7,800	98.5	100	131.5	129	1.5	2.07	NN3018K
NN3019	NN3019K	95	145	37	132	1.5	150	246	6,300	7,500	103.5	106	136.5	134	1.5	2.17	NN3019K
NN3020	NN3020K	100	150	37	137	1.5	157	265	6,100	7,200	108.5	112	141.5	139	1.5	2.26	NN3020K
NN3021	NN3021K	105	160	41	146	2	198	320	5,800	6,800	115	116	150	148	2	2.89	NN3021K
NN3022	NN3022K	110	170	45	155	2	229	375	5,400	6,400	120	122	160	157	2	3.68	NN3022K
NN3024	NN3024K	120	180	46	165	2	239	405	5,100	6,000	130	132	170	167	2	3.98	NN3024K
NN3026	NN3026K	130	200	52	182	2	284	475	4,600	5,400	140	144	190	183	2	5.92	NN3026K
NN3028	NN3028K	140	210	53	192	2	298	515	4,300	5,100	150	154	200	194	2	6.44	NN3028K
NN3030	NN3030K	150	225	56	206	2.1	335	585	4,100	4,800	162	164	213	208	2	7.81	NN3030K
NN3032	NN3032K	160	240	60	219	2.1	375	660	3,800	4,500	172	174	228	221	2	8.92	NN3032K
NN3034	NN3034K	170	260	67	236	2.1	450	805	3,500	4,200	182	184	248	238	2	12.6	NN3034K
NN3036	NN3036K	180	280	74	255	2.1	565	995	3,300	3,900	192	196	268	257	2	16.6	NN3036K
NN3038	NN3038K	190	290	75	265	2.1	595	1,080	3,200	3,700	202	206	278	267	2	17.5	NN3038K
NN3040	NN3040K	200	310	82	282	2.1	655	1,170	2,900	3,500	212	216	298	285	2	21.6	NN3040K
NN3044	NN3044K	220	340	90	310	3	815	1,480	2,700	3,200	234	238	326	313	2.5	28.4	NN3044K
NN3048	NN3048K	240	360	92	330	3	855	1,600	2,500	3,000	254	256	346	333	2.5	31.8	NN3048K
NN3052	NN3052K	260	400	104	364	4	1,080	2,070	2,300	2,700	278	280	382	367	3	46.0	NN3052K
NN3056	NN3056K	280	420	106	384	4	1,080	2,080	2,100	2,500	298	300	402	387	3	49.6	NN3056K
NN3060	NN3060K	300	460	118	418	4	1,430	2,740	2,000	2,300	318	325	442	421	3	68.7	NN3060K
NN3064	NN3064K	320	480	121	438	4	1,430	2,750	1,900	2,200	338	345	462	442	3	74.0	NN3064K

Double row Cylindrical Roller Bearings

NNU4900 Series

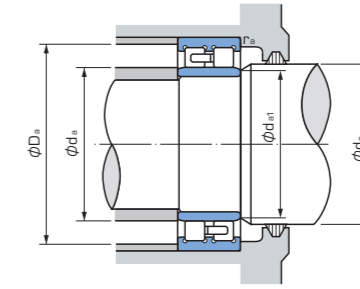
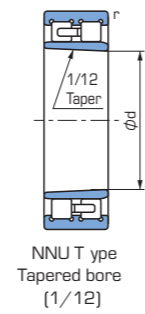
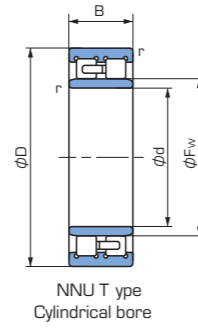

Bearing No.		Boundary dimensions (mm)					Basic dynamic load rating Cr (kN)	Basic static load rating Cor (kN)	Limiting speed (min ⁻¹)		Corner radius (mm)					Mass (kg) (Reference) (Tapered bore)	Bearing No. (Tapered bore)	
Cylindrical bore	Tapered bore	d	D	B	Ew	r _{min}			Grease lubrication	Oil lubrication	da		da ₁ min	dc min	Da max			ra max
							min	max										
NNU4920	NNU4920K	100	140	40	113	1.1	155	305	6,300	7,500	106.5	111	110	115	133.5	1	1.77	NNU4920K
NNU4921	NNU4921K	105	145	40	118	1.1	161	325	6,100	7,200	111.5	116	115	120	138.5	1	1.85	NNU4921K
NNU4922	NNU4922K	110	150	40	123	1.1	167	335	5,800	6,900	116.5	121	120	125	143.5	1	1.93	NNU4922K
NNU4924	NNU4924K	120	165	45	134.5	1.1	183	360	5,300	6,300	126.5	133	130	137	158.5	1	2.65	NNU4924K
NNU4926	NNU4926K	130	180	50	146	1.5	275	565	4,900	5,800	138	144	142	148	172	1.5	3.55	NNU4926K
NNU4928	NNU4928K	140	190	50	156	1.5	283	585	4,600	5,400	148	154	151	158	182	1.5	3.80	NNU4928K
NNU4930	NNU4930K	150	210	60	168.5	2	350	715	4,200	5,000	159	166	162	171	201	2	5.95	NNU4930K
NNU4932	NNU4932K	160	220	60	178.5	2	365	760	4,000	4,700	169	176	172	182	211	2	6.25	NNU4932K
NNU4934	NNU4934K	170	230	60	188.5	2	375	805	3,800	4,500	179	186	182	192	221	2	6.60	NNU4934K
NNU4936	NNU4936K	180	250	69	202	2	480	1,020	3,500	4,200	189	199	194	205	241	2	9.50	NNU4936K
NNU4938	NNU4938K	190	260	69	212	2	485	1,060	3,400	4,000	199	209	204	215	251	2	10.0	NNU4938K
NNU4940	NNU4940K	200	280	80	225	2.1	570	1,220	3,200	3,700	211	222	214	228	269	2	10.1	NNU4940K
NNU4944	NNU4944K	220	300	80	245	2.1	600	1,330	2,900	3,400	231	242	234	248	289	2	15.5	NNU4944K
NNU4948	NNU4948K	240	320	80	265	2.1	625	1,450	2,700	3,200	251	262	254	269	309	2	17.0	NNU4948K
NNU4952	NNU4952K	260	360	100	292	2.1	935	2,100	2,400	2,900	271	288	276	296	349	2	28.3	NNU4952K
NNU4956	NNU4956K	280	380	100	312	2.1	960	2,230	2,300	2,700	291	308	296	316	369	2	30.3	NNU4956K
NNU4960	NNU4960K	300	420	118	339	3	1,230	2,880	2,100	2,500	313	335	320	343	407	2.5	46.7	NNU4960K
NNU4964	NNU4964K	320	440	118	359	3	1,270	3,050	2,000	2,300	333	335	340	363	427	2.5	49.6	NNU4964K

Dimension Tables

Types and Designs

7900/7000/7200

BNH

TAB/TBH

NN3000/NNU4900

XRN/XRG

TAB/T AU/T AF-X/XS1/W1

Cross Tapered Roller Bearings

XRN/XRG Series



A bearing that provides functions equivalent to a duplex tapered roller bearing, but in the size of a single bearing. The rolling elements are arranged in alternating orientation between the separable ring and the primary ring.

Features

- A bearing that can stand up to radial loads, axial loads, and moment loads.
- Bearing applications can be simplified, fewer components reduce weight and size, reduced assembly time.
- Shaft thermal expansion has minimal effect on bearing preload promoting machine accuracy.
- Tapered rollers are used and the center of rotation is maintained for smooth rotation, even under preload.
- Polyamide resin spacers are inserted between rollers to minimize roller-to-roller friction (except XRGV type).
- Angle of contact is approximately 45°.

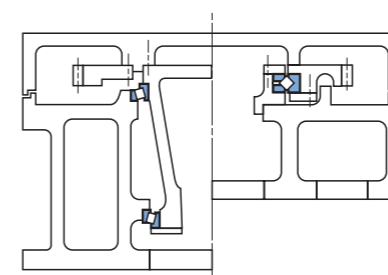

Duplex Tapered Roller Bearings Cross Tapered Roller Bearings
Installation Example of Tapered Roller Bearing and Cross Tapered Roller Bearing

Accuracy

Nachi defines its own accuracy standards. See page 12 for details.

Mechanism

The XRN Series is a separable inner ring, primary outer ring type bearing, intended mainly for applications where the focus is on outer ring accuracy under outer ring rotation. The XRG Series, on the other hand mainly is used where the focus is on inner ring rotation accuracy during inner ring rotation.

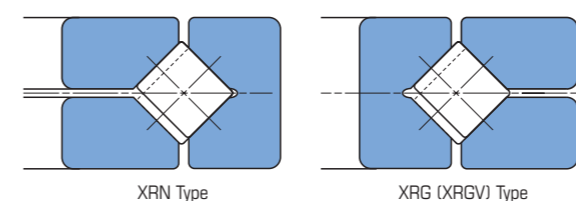

Main Applications

- Work table of a machining center, grinding machine, etc.
- Work spindle of a lathe, grinding machine, etc.
- Large-scale milling machine, drilling machine, or other indexing machine.
- Pivot of parabolic antenna, etc.

Nomenclature of Bearing Numbers

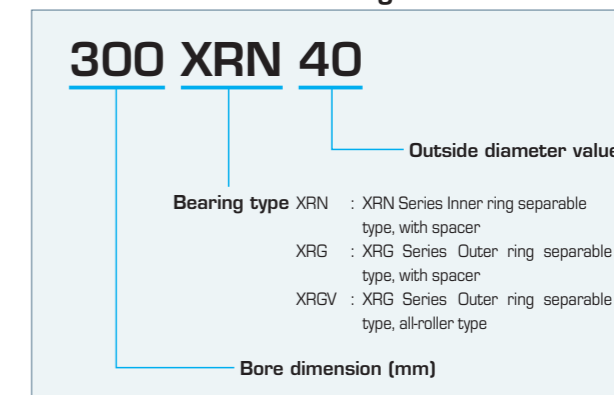

Axial Load and Axial Displacement

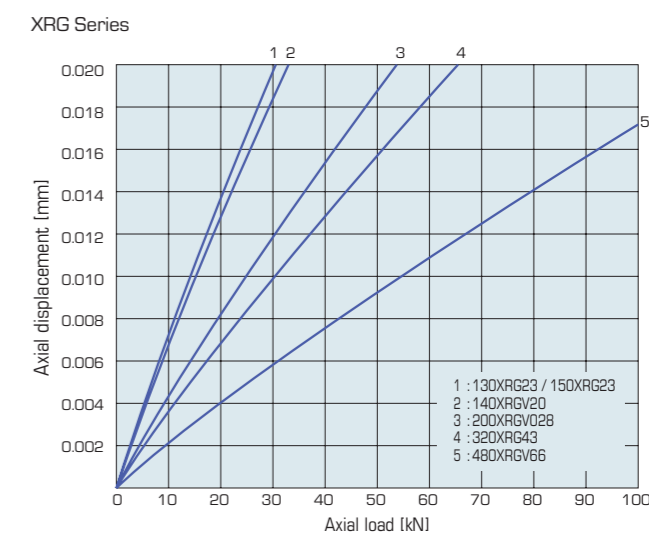
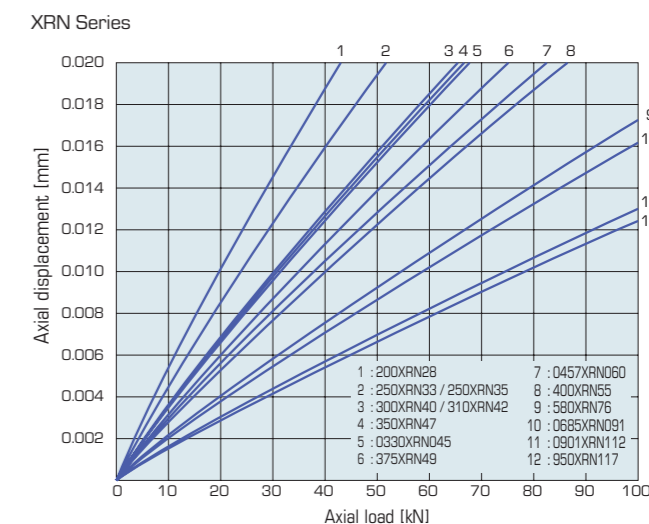

Cross Tapered Roller Bearings

XRN Series

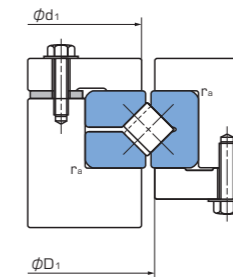
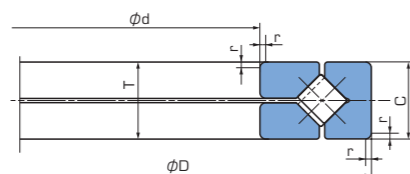

Bearing No.	Boundary dimensions (mm)					Basic dynamic load rating Ca (kN)	Basic static load rating Coa (kN)		Limiting speed (min ⁻¹)		Corner radius (mm)			Mass (kg) (Reference)	Bearing No.
	d	D	T	C	r				Grease lubrication	Oil lubrication	d ₁ min	D ₁ max	r _a max		
150XRN23	150	230	30	30	1.5	105	335		600	1,200	182	197	1	5.11	150XRN23
200XRN28	200	280	30	30	1.5	144	520		480	950	235	249	1	6.43	200XRN28
250XRN33	250	330	30	30	1	164	650		400	800	285	298	1	7.77	250XRN33
250XRN35	250	350	40	40	3	170	680		400	800	302	312	1.5	13.6	250XRN35
300XRN40	300	400	38	38	3	268	985		330	650	345	369	2.5	14.8	300XRN40
310XRN42	310	420	40	40	2.5	260	1,070		320	630	358	380	2	18.1	310XRN42
0330XRN045	330.2	457.2	63.5	63.5	3.3	400	1,540		290	580	380	409	2	35.4	0330XRN045
350XRN47	350	470	50	50	3	284	1,230		280	560	410	424	1.5	27.7	350XRN47
375XRN49	375	490	45	45	2.5	290	1,280		260	530	430	445	1.5	25.5	375XRN49
400XRN55	400	550	60	60	3.5	365	1,900		250	500	475	492	1.5	48.8	400XRN55
0457XRN060	457.2	609.6	63.5	63.5	3.3	370	1,670		220	440	535	554	2	57.1	0457XRN060
580XRN76	580	760	80	80	6.4	830	3,800		170	340	667	691	4	108	580XRN76
0685XRN091	685.8	914.4	79.375	79.375	3.3	1,090	5,000		140	280	807	834	2	161	0685XRN091
950XRN117	950	1,170	85	85	3	1,440	7,400		100	200	1,050	1,084	2.5	218	950XRN117

XRG Series

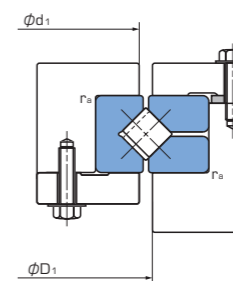
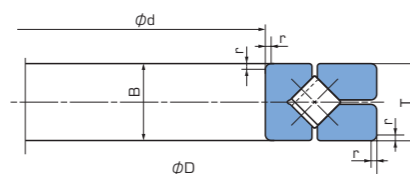

Bearing No.	Boundary dimensions (mm)					Basic dynamic load rating Ca (kN)	Basic static load rating Coa (kN)		Limiting speed (min ⁻¹)		Corner radius (mm)			Mass (kg) (Reference)	Bearing No.
	d	D	T	B	r				Grease lubrication	Oil lubrication	d ₁ min	D ₁ max	r _a max		
130XRG23	130	230	30	30	1.5	105	335		650	1,250	182	197	1	5.97	130XRG23
140XRGV20	140	200	25	25	1.5	89	299		680	1,350	162	176	1	2.86	140XRGV20
150XRG23	150	230	30	30	1.5	105	335		600	1,200	182	197	1	5.11	150XRG23
200XRGV028	200	285	30	30	1	170	655		480	950	235	249	1	7.13	200XRGV028
320XRG43	320	430	40	40	2.5	260	1,070		300	600	358	382	2	18.9	320XRG43
480XRGV66	480	660	50	49.5	4	405	2,110		200	400	550	572	3	61.0	480XRGV66

Ball Screw Support Bearings

TAB Series

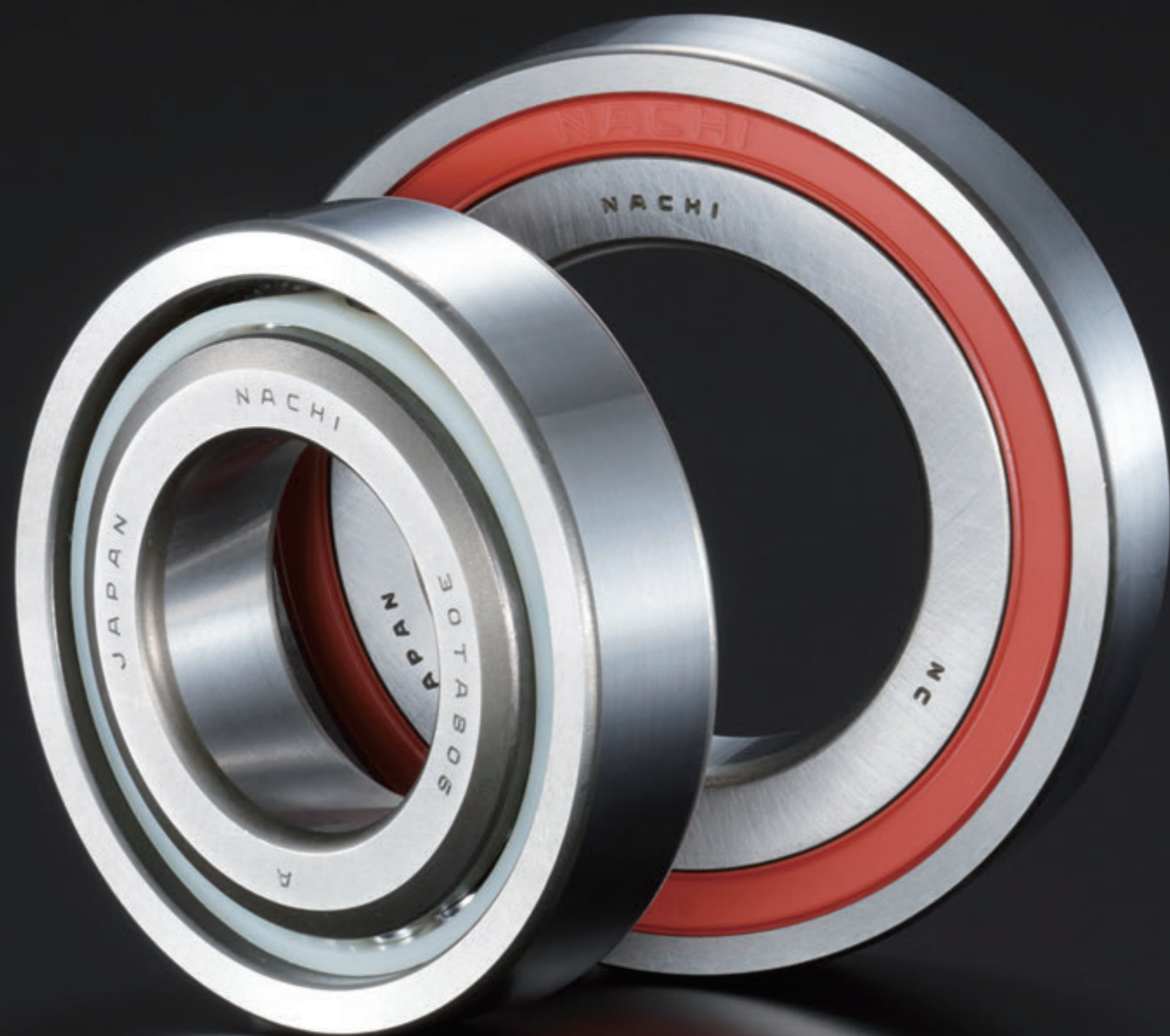

Nomenclature of Bearing Numbers

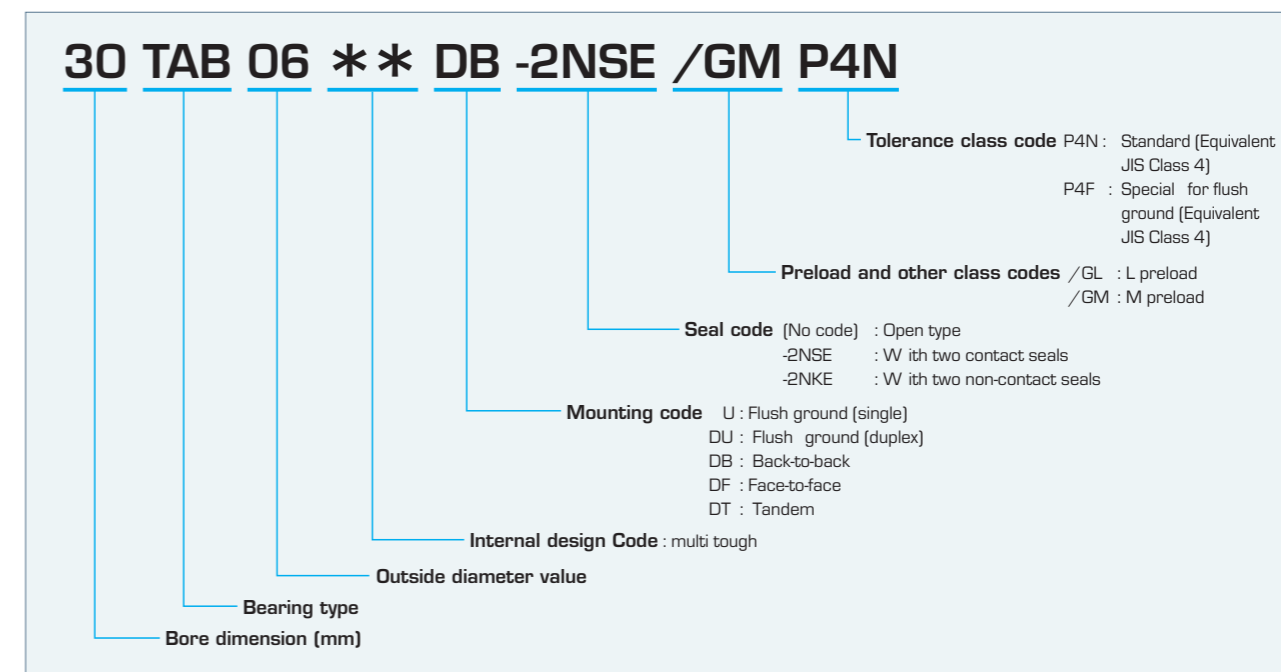

Features

- Resin cage and more balls than previous ball bearings for greater rigidity.
- Combination bearings are provided with preset preloads, eliminating the need for troublesome installation adjustment using shims and torque measurements.
- A contact angle of 60° and has the ability to handle radial and axial loads creates a compact bearing.
- The seal type provides a choice between contact seal and non-contact seal to suit specific applications

Contact Angle

The contact angle is 60°.

Cage

A ball guided polyamide resin cage is provided as standard.

Accuracy

P4N is standard. See Class 4 in page 13 for details. P4F can also be applied to TAB flash ground type

Preload

Two types of preload settings are available. See page 23 for details.

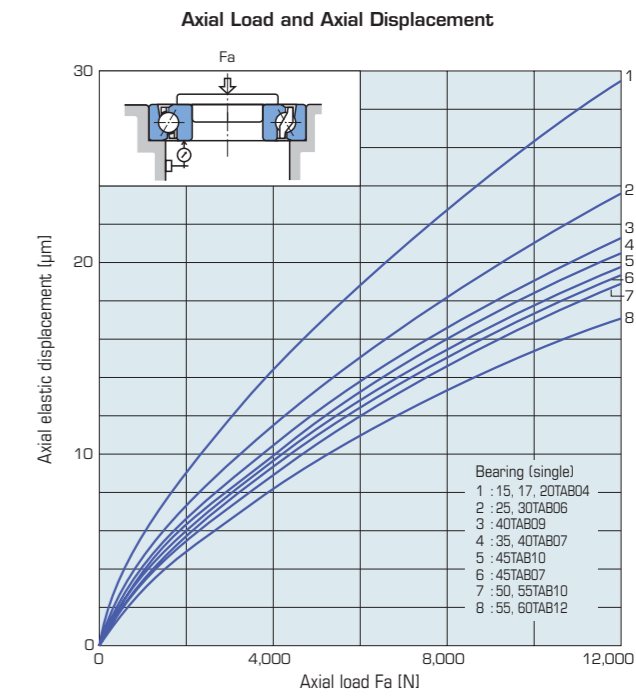

Dimension Tables Types and Designs 7900/7000/7200 BNH TAH/TBH NN3000/NNU4900 XRN/XRG TAB/T AU/T AF-X/XY51/W1

Ball Screw Support Bearings

TAB Series

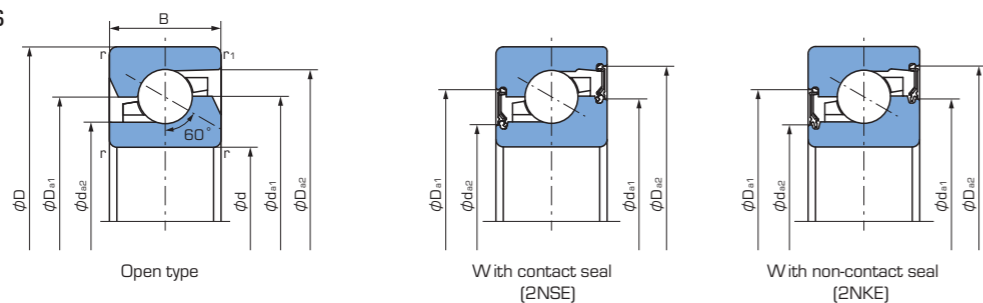

Dynamic equivalent axial load $P_a = X F_r + Y F_a$

No. of bearings in set	2		3			4				
	1 row	2 rows	1 row	2 rows	3 rows	1 row	2 rows	3 rows	4 rows	
$F_a/F_r \leq 2.17$	X	1.90	-	1.43	2.33	-	1.17	2.33	2.53	-
	Y	0.54	-	0.77	0.35	-	0.89	0.35	0.26	-
$F_a/F_r > 2.17$	X	0.92	0.92	0.92	0.92	0.92	0.92	0.92	0.92	0.92
	Y	1	1	1	1	1	1	1	1	1

Bearing No.	Boundary dimensions (mm)					Basic dynamic load rating ⁽²⁾ Ca (kN)		Axial limiting load ⁽³⁾ (kN)	Limiting speed ⁽⁴⁾ (min ⁻¹)		Reference dimensions (mm)				Mass (kg) (Reference)	Bearing No.
	d	D	B	r _{min}	r _{1 min}	Standard	Multi-tough		Grease lubrication	Oil lubrication	da ₁	da ₂	Da ₁	Da ₂		
15TAB04	15	47	15	1 ⁽¹⁾	0.6	25.9	32.5	32.0	6,300	8,000	33.7	26.8	33.5	41.0	0.14	15TAB04
15TAB04-2NKE	15	47	15	1 ⁽¹⁾	0.6	25.9	32.5	32.0	6,300	-	32.9	26.0	35.5	41.8	0.14	15TAB04-2NKE
15TAB04-2NSE	15	47	15	1 ⁽¹⁾	0.6	25.9	32.5	32.0	6,300	-	32.9	26.0	35.5	41.8	0.14	15TAB04-2NSE
17TAB04	17	47	15	1	0.6	25.9	32.5	32.0	6,300	8,000	33.7	26.8	33.5	41.0	0.13	17TAB04
17TAB04-2NKE	17	47	15	1	0.6	25.9	32.5	32.0	6,300	-	32.9	26.0	35.5	41.8	0.13	17TAB04-2NKE
17TAB04-2NSE	17	47	15	1	0.6	25.9	32.5	32.0	6,300	-	32.9	26.0	35.5	41.8	0.13	17TAB04-2NSE
20TAB04	20	47	15	1	0.6	25.9	32.5	32.0	6,300	8,000	33.7	26.8	33.5	41.0	0.12	20TAB04
20TAB04-2NKE	20	47	15	1	0.6	25.9	32.5	32.0	6,300	-	32.9	26.0	35.5	41.8	0.12	20TAB04-2NKE
20TAB04-2NSE	20	47	15	1	0.6	25.9	32.5	32.0	6,300	-	32.9	26.0	35.5	41.8	0.12	20TAB04-2NSE
25TAB06	25	62	15	1	0.6	29.9	38.0	46.4	4,650	6,000	46.2	39.7	46.0	53.4	0.24	25TAB06
25TAB06-2NKE	25	62	15	1	0.6	29.9	38.0	46.4	4,650	-	45.0	38.5	47.8	55.0	0.24	25TAB06-2NKE
25TAB06-2NSE	25	62	15	1	0.6	29.9	38.0	46.4	4,650	-	45.0	38.5	47.8	55.0	0.24	25TAB06-2NSE
30TAB06	30	62	15	1	0.6	29.9	38.0	46.4	4,650	6,000	46.2	39.7	46.0	53.4	0.21	30TAB06
30TAB06-2NKE	30	62	15	1	0.6	29.9	38.0	46.4	4,650	-	45.0	38.5	47.8	55.0	0.21	30TAB06-2NKE
30TAB06-2NSE	30	62	15	1	0.6	29.9	38.0	46.4	4,650	-	45.0	38.5	47.8	55.0	0.21	30TAB06-2NSE
35TAB07	35	72	15	1	0.6	32.5	41.0	54.3	3,750	5,000	56.2	49.7	56.0	63.4	0.29	35TAB07
35TAB07-2NKE	35	72	15	1	0.6	32.5	41.0	54.3	3,750	-	55.0	48.5	57.8	64.9	0.29	35TAB07-2NKE
35TAB07-2NSE	35	72	15	1	0.6	32.5	41.0	54.3	3,750	-	55.0	48.5	57.8	64.9	0.29	35TAB07-2NSE
40TAB07	40	72	15	1	0.6	32.5	41.0	54.3	3,750	5,000	56.2	49.7	56.0	63.4	0.26	40TAB07
40TAB07-2NKE	40	72	15	1	0.6	32.5	41.0	54.3	3,750	-	55.0	48.5	57.8	64.9	0.26	40TAB07-2NKE
40TAB07-2NSE	40	72	15	1	0.6	32.5	41.0	54.3	3,750	-	55.0	48.5	57.8	64.9	0.26	40TAB07-2NSE
40TAB09	40	90	20	1	0.6	65.0	82.0	101	3,150	4,000	67.2	57.2	67.0	78.4	0.62	40TAB09
40TAB09-2NKE	40	90	20	1	0.6	65.0	82.0	101	3,150	-	65.7	55.7	69.8	80.8	0.62	40TAB09-2NKE
40TAB09-2NSE	40	90	20	1	0.6	65.0	82.0	101	3,150	-	65.7	55.7	69.8	80.8	0.62	40TAB09-2NSE
45TAB07	45	75	15	1	0.6	33.5	42.5	59.5	3,400	4,500	61.7	55.2	61.5	68.9	0.25	45TAB07
45TAB07-2NKE	45	75	15	1	0.6	33.5	42.5	59.5	3,400	-	60.5	54.0	63.3	70.3	0.25	45TAB07-2NKE
45TAB07-2NSE	45	75	15	1	0.6	33.5	42.5	59.5	3,400	-	60.5	54.0	63.3	70.3	0.25	45TAB07-2NSE
45TAB10	45	100	20	1	0.6	68.0	86.0	113	2,850	3,500	74.2	64.2	74.0	85.4	0.79	45TAB10
45TAB10-2NKE	45	100	20	1	0.6	68.0	86.0	113	2,850	-	72.7	62.7	76.8	87.8	0.79	45TAB10-2NKE
45TAB10-2NSE	45	100	20	1	0.6	68.0	86.0	113	2,850	-	72.7	62.7	76.8	87.8	0.79	45TAB10-2NSE
50TAB10	50	100	20	1	0.6	69.5	88.0	119	2,700	3,500	78.2	68.2	78.0	89.4	0.72	50TAB10
50TAB10-2NKE	50	100	20	1	0.6	69.5	88.0	119	2,700	-	76.7	66.7	80.8	91.8	0.72	50TAB10-2NKE
50TAB10-2NSE	50	100	20	1	0.6	69.5	88.0	119	2,700	-	76.7	66.7	80.8	91.8	0.72	50TAB10-2NSE
55TAB10	55	100	20	1	0.6	69.5	88.0	119	2,700	3,500	78.2	68.2	78.0	89.4	0.95	55TAB10
55TAB10-2NKE	55	100	20	1	0.6	69.5	88.0	119	2,700	-	76.7	66.7	80.8	91.8	0.95	55TAB10-2NKE
55TAB10-2NSE	55	100	20	1	0.6	69.5	88.0	119	2,700	-	76.7	66.7	80.8	91.8	0.95	55TAB10-2NSE
55TAB12	55	120	20	1	0.6	73.0	92.5	137	2,300	3,000	92.2	82.2	92.0	103.4	1.15	55TAB12
55TAB12-2NKE	55	120	20	1	0.6	73.0	92.5	137	2,300	-	90.7	80.7	94.8	105.8	1.15	55TAB12-2NKE
55TAB12-2NSE	55	120	20	1	0.6	73.0	92.5	137	2,300	-	90.7	80.7	94.8	105.8	1.15	55TAB12-2NSE
60TAB12	60	120	20	1	0.6	73.0	92.5	137	2,300	3,000	92.2	82.2	92.0	103.4	1.08	60TAB12
60TAB12-2NKE	60	120	20	1	0.6	73.0	92.5	137	2,300	-	90.7	80.7	94.8	105.8	1.08	60TAB12-2NKE
60TAB12-2NSE	60	120	20	1	0.6	73.0	92.5	137	2,300	-	90.7	80.7	94.8	105.8	1.08	60TAB12-2NSE

[Note 1] Minimum r for inner ring is 0.6.
 [Note 2] When the axial load is on a 2-row or 3-row arrangement, the values in the table should be multiplied by 1.62 and 2.16 respectively.
 [Note 3] When the axial load is on a 2-row or 3-row arrangement, the values in the table should be multiplied by 2 and 3 respectively.
 [Note 4] Limiting speed for M preload.

Ball Screw Support Bearings

TAU Series



Nomenclature of Bearing Numbers

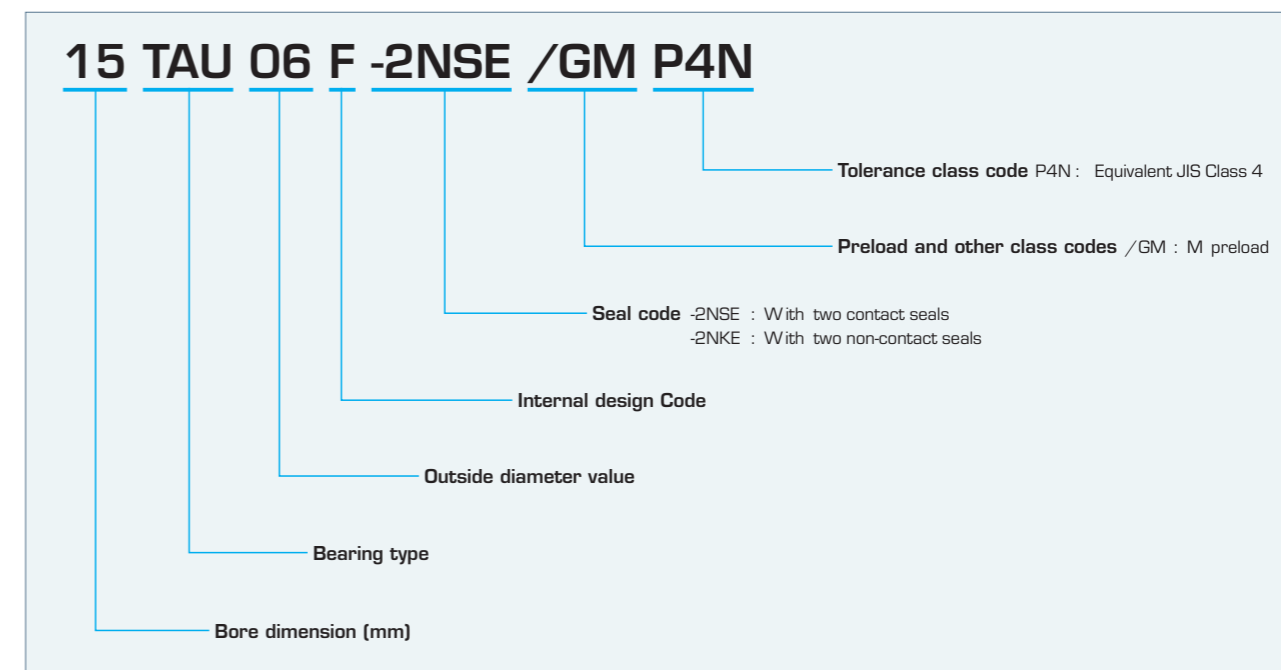

Features

- Perimeter structures combined in housing and outer ring integrated to improve maintainability, and form is more compact.
- Re-greasing when needed is possible through grease ports.
- Contact seal is standard with high grade grease retention and intrusion protection.

Contact Angle

- The contact angle is 60°.

Cage

- A ball guide polyamide resin cage is provided as standard. The polyamide resin cage should be used under temperatures lower than 120°.

Accuracy

- Equivalent JIS Class 4 is standard. See page 13 for details.

Preload

- M preload as standard. See page 23 for details.

Ball Screw Support Bearings

TAU Series

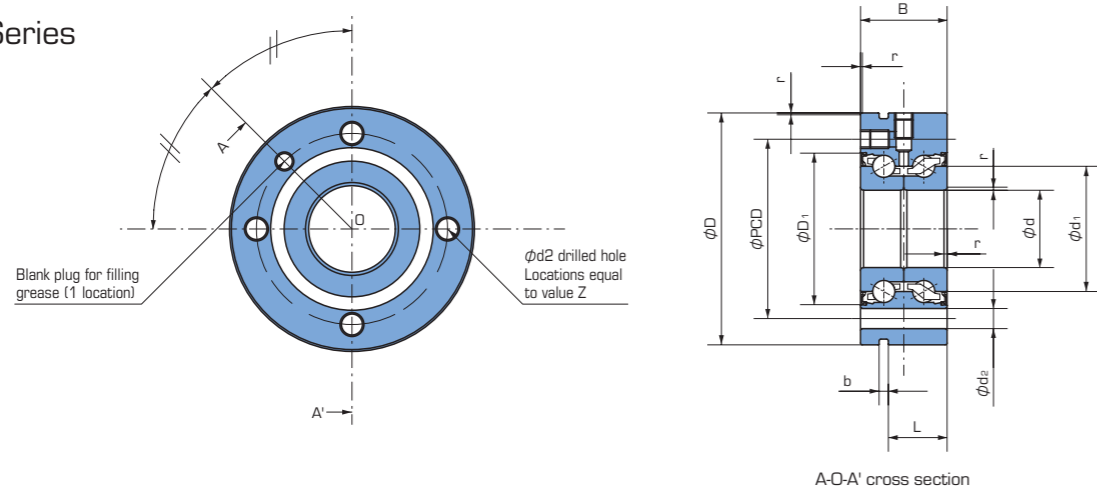

Bearing No.	Boundary dimensions (mm)				Basic dynamic load rating Ca (kN)	Axial limiting load (kN)	Limiting speed (min ⁻¹)	Reference dimensions (mm)							Mass (kg) (Reference)	Bearing No.
	d	D	B	r _{min}				d ₁	D ₁	PCD	d ₂	Z	L	b		
15TAU06F	15	60	25	0.6	19.0	20.0	7,000	27.4	35.8	46	6.8	3	17	3	0.45	15TAU06F
17TAU06F	17	62	25	0.6	20.8	23.7	6,500	30.4	38.8	48	6.8	3	17	3	0.46	17TAU06F
20TAU06F	20	68	28	0.6	26.0	29.9	5,800	32.9	42.0	53	6.8	4	19	3	0.63	20TAU06F
25TAU07F	25	75	28	0.6	27.6	34.5	5,100	38.0	48.2	58	6.8	4	19	3	0.73	25TAU07F
30TAU08F	30	80	28	0.6	29.2	39.5	4,600	43.0	53.2	63	6.8	6	19	3	0.82	30TAU08F
30TAU10F	30	100	38	0.6	62.5	76.5	4,100	50.0	64.8	80	8.8	8	30	3	1.70	30TAU10F
35TAU09F	35	90	34	0.6	42.0	58.5	3,900	51.5	63.3	75	8.8	4	25	3	1.17	35TAU09F
40TAU10F	40	100	34	0.6	43.0	62.0	3,600	55.5	67.3	80	8.8	4	25	3	1.47	40TAU10F
40TAU11F	40	115	46	0.6	81.0	107	3,200	63.7	81.4	94	8.8	12	36	3	2.52	40TAU11F
50TAU11F	50	115	34	0.6	46.5	76.5	3,000	68.7	81.8	94	8.8	6	25	3	1.86	50TAU11F
50TAU14F	50	140	54	0.6	113	159	2,600	77.7	97.8	113	11.0	12	45	3	4.44	50TAU14F
60TAU14F	60	145	45	0.6	91.0	140	2,400	83.7	101.4	120	8.8	8	35	3	3.87	60TAU14F

Ball Screw Support Bearings

TAF-X Series



Nomenclature of Bearing Numbers

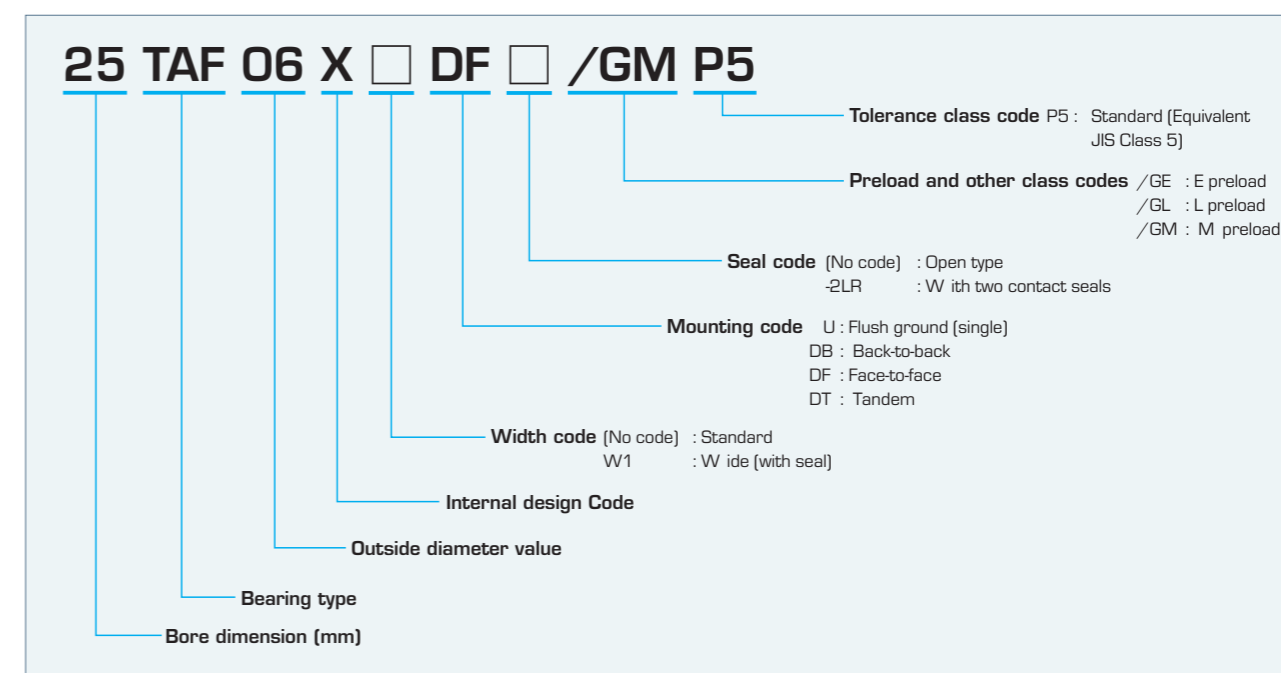

Features

- A large-diameter ball and large contact angle provides the high thrust load capacity needed for the high loads of the ball screw used in injection molding machines.
- A one-piece molded resin cage that combines both greater accuracy and strength, and the ability to withstand repeated high-speed switching between forward and reverse.

Contact Angle

The contact angle is 55°.

Accuracy

Equivalent JIS Class 5 is standard. See page 14 for details.

Preload

Three types of preload settings are available. See page 24 for details. Standard preloads are M-preloads if less than 80T AF17X, and E-preloads if greater than 80T AF21X.

Cage

A ball guide polyamide resin cage is provided as standard.

With Seal

Contact seals are also available for improved intrusion protection and grease retention. (They are wider than open types.)

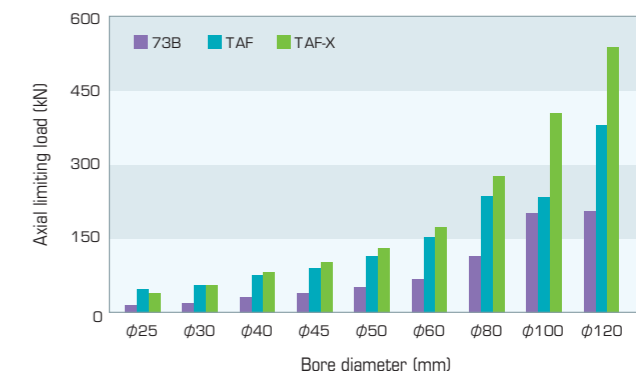
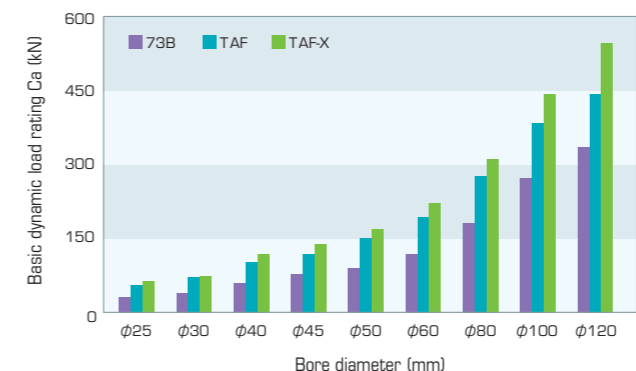

Dimension Tables Types and Designs 7900/7000/7200 BNH TAH/TBH NN3000/NUU4900 XRN/XRG TAB/T AU/T AF-X/XY51/W1

Ball Screw Support Bearings

TAF-X Series

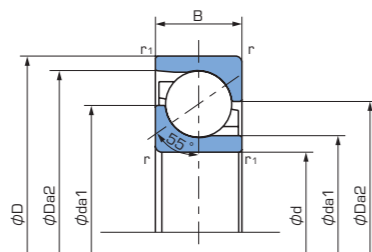

Dynamic equivalent axial load $P_a = XFr + YFa$

No. of bearings in set	2	
	1 row	2 rows
$F_a/F_r \leq 1.79$	X	1.60
	Y	0.56
$F_a/F_r > 1.79$	X	0.81
	Y	1

Bearing No.	Boundary dimensions (mm)					Basic dynamic load rating ⁽¹⁾ Ca (kN)	Axial limiting load ⁽²⁾ (kN)	Limiting speed ⁽³⁾ (min ⁻¹)	Reference dimensions (mm)				Mass (kg) (Reference)	Bearing No.
	d	D	B	r _{min}	r _{1min}				Grease lubrication	da ₁	da ₂	Da ₁		
25TAF05X	25	52	15	1.0	0.6	38.0	25.7	7,700	38.7	31.6	39.7	48.0	0.140	25TAF05X
25TAF06X	25	62	17	1.1	0.6	64.5	40.5	6,800	43.0	32.7	44.5	56.6	0.230	25TAF06X
30TAF07X	30	72	19	1.1	0.6	78.5	56.9	5,800	50.4	38.8	52.1	65.8	0.357	30TAF07X
35TAF09X	35	90	23	1.5	1.0	119	85.5	4,600	64.3	50.8	66.3	82.2	0.713	35TAF09X
40TAF09X	40	90	23	1.5	1.0	119	85.5	4,600	64.3	50.8	66.3	82.2	0.650	40TAF09X
40TAF11X	40	110	27	2.0	1.0	173	131	3,700	79.2	62.4	81.7	101.0	1.28	40TAF11X
45TAF10X	45	100	25	1.5	1.0	139	103	4,100	71.8	56.9	74.0	91.1	0.880	45TAF10X
45TAF11X	45	110	27	2.0	1.0	173	131	3,700	79.2	62.4	81.7	101.0	1.21	45TAF11X
50TAF11X	50	110	27	2.0	1.0	173	131	3,700	79.2	62.4	81.7	101.0	1.15	50TAF11X
50TAF13X	50	130	31	2.1	1.1	225	174	3,100	94.1	74.7	96.9	119.5	1.98	50TAF13X
60TAF13X	60	130	31	2.1	1.1	225	174	3,100	94.1	74.7	96.9	119.5	1.77	60TAF13X
60TAF17X	60	170	39	2.1	1.1	315	280	2,400	123.8	99.3	127.4	155.8	4.42	60TAF17X
80TAF17X	80	170	39	2.1	1.1	315	280	2,400	123.8	99.3	127.4	155.8	3.76	80TAF17X
80TAF21X	80	215	47	3.0	1.1	445	405	1,900	155.2	125.0	160.5	196.2	8.54	80TAF21X
100TAF21X	100	215	47	3.0	1.1	445	405	1,900	155.2	125.0	160.5	196.2	7.53	100TAF21X
100TAF26X	100	260	55	3.0	1.1	550	540	1,500	187.1	153.4	193.3	234.9	14.7	100TAF26X
120TAF26X	120	260	55	3.0	1.1	550	540	1,500	187.1	153.4	193.3	234.9	13.2	120TAF26X

[Note 1] When the axial load is on a 2-row, 3-row, or 4-row arrangement, the values in the table should be multiplied by 1.62, 2.16, and 2.64 respectively.
 [Note 2] When the axial load is on a 2-row, 3-row, or 4-row arrangement, the values in the table should be multiplied by 2, 3, and 4 respectively.
 [Note 3] Limiting speed for standard preload.

Ball Screw Support Bearings

XYS1 Series



Nomenclature of Bearing Numbers

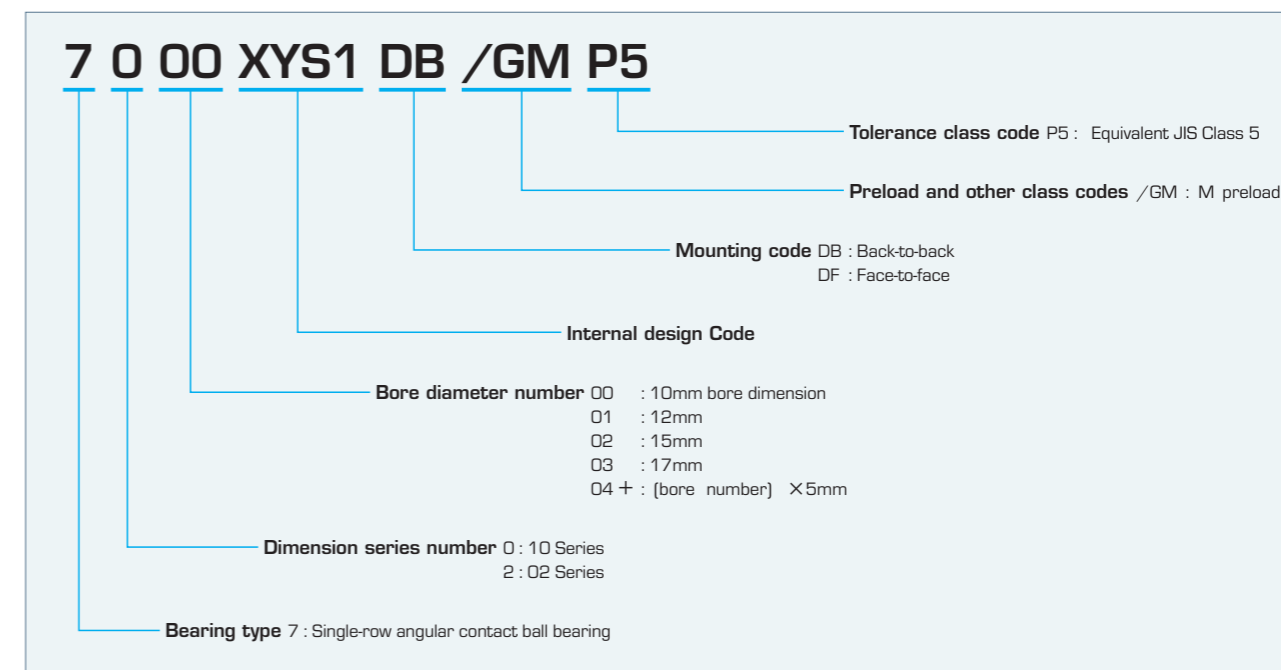

Features

- Improved load capacity and critical axial load in the same dimensions as the standard angular contact ball bearings 70 Series and 72 Series. The peripheral components can be replaced as is.
- Combination bearings are provided with preset preloads, eliminating the need for troublesome installation adjustment using shims and torque measurements.

Contact Angle

- The contact angle is 30°.

Cage

- A ball guide polyamide resin cage is provided as standard. The polyamide resin cage should be used under temperatures lower than 120°.

Dimensional Accuracy, Rotational Accuracy

- Equivalent JIS Class 5 is standard. See page 10 for details.

Preload

- M preload as standard. See page 25 for details.

Ball Screw Support Bearings

XYS1 Series

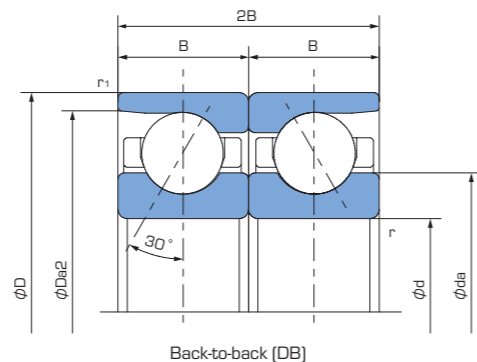

Back-to-back (DB)

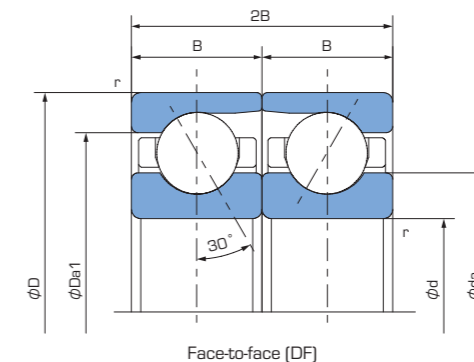

Face-to-face (DF)

Bearing No.	Boundary dimensions (mm)					Basic dynamic load rating C_a (kN)	Basic static load rating C_a (kN)	Axial limiting load (kN)	Limiting speed (min ⁻¹) Grease lubrication	Reference dimensions (mm)			Mass (kg) (Reference)	Bearing No.
	d	D	B	r _{min}	r _{1 min}					da	Da ₁	Da ₂		
7000XYS1	10	26	8	0.3	0.15	6.20	8.09	3.35		15.7	20.4	23.0	0.019	7000XYS1
7001XYS1	12	28	8	0.3	0.15	6.65	92.9	3.70		17.7	22.4	25.0	0.021	7001XYS1
7002XYS1	15	32	9	0.3	0.15	8.80	12.7	5.50		20.9	26.3	29.3	0.028	7002XYS1
7003XYS1	17	35	10	0.3	0.15	9.30	14.3	6.01		23.3	28.8	31.9	0.040	7003XYS1
7004XYS1	20	42	12	0.6	0.30	13.2	21.0	9.27		27.9	34.4	38.0	0.070	7004XYS1
7203XYS1	17	40	12	0.6	0.30	13.8	20.6	9.36		25.6	32.6	36.4	0.067	7203XYS1
7204XYS1	20	47	14	1.0	0.60	18.6	27.5	11.4		29.8	38.4	43.1	0.099	7204XYS1
7205XYS1	25	52	15	1.0	0.60	21.0	34.9	14.7		34.9	43.4	48.2	0.122	7205XYS1
7206XYS1	30	62	16	1.0	0.60	28.4	48.8	18.9		41.5	51.7	57.3	0.188	7206XYS1

Dimension Tables

Types and Designs

7900/7000/7200

BNH

TAH/TBH

NN3000/NNU4900

XRN/XRG

TAB/TAU/TAFX/XYS1/W1

Ball Screw Support Bearings

W1 Series



Nomenclature of Bearing Numbers

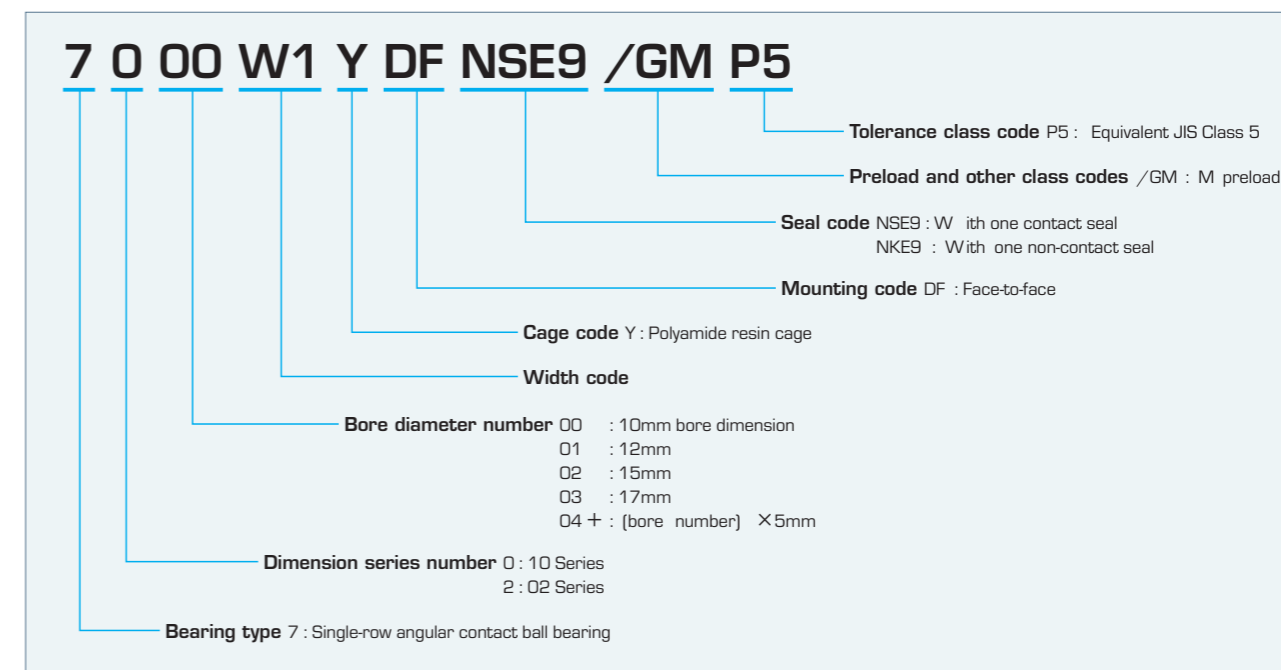

Features

- NACHI's proprietary seals, which are proven in deep-groove ball bearings, are used to retain injected grease for greater sealing and to prevent contamination by foreign matter.
- Superior low-start-up torque and low-rotational torque can be used for low-energy applications.
- Combination bearings are provided with preset preloads, eliminating the need for troublesome installation adjustment using shims and torque measurements.
- Polyamide resin cage and high-performance grease produce low-noise design based on standard A-type angular contact ball bearings.

Contact Angle

- The contact angle is 30°.

Dimensions

- Wider than A-type angular contact ball bearings.

Cage

- A ball guide polyamide resin cage is provided as standard. The polyamide resin cage should be used under temperatures lower than 120°.

Dimensional Accuracy, Rotational Accuracy

- Equivalent JIS Class 5 is standard. See page 10 for details.

Preload

- M preload as standard. See page 25 for details.

Ball Screw Support Bearings

W1 Series

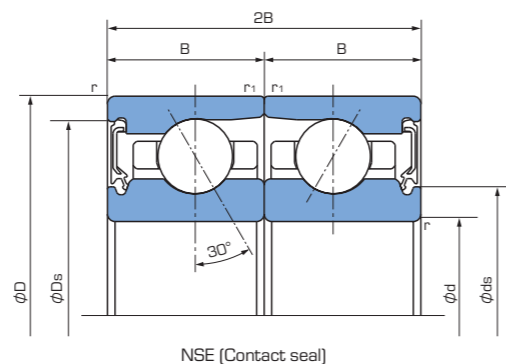

NSE (Contact seal)

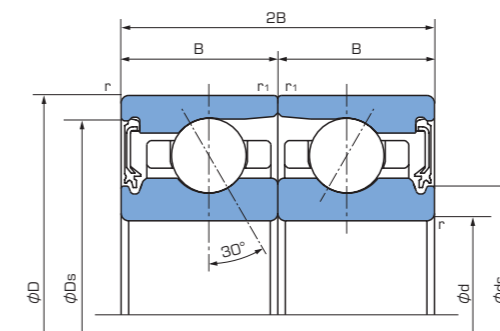

NKE (Non-contact seal)

Bearing No.		Boundary dimensions (mm)					Basic dynamic load rating C_a (kN)	Basic static load rating C_a (kN)	Limiting speed (min ⁻¹)		Reference dimensions (mm)		Mass (kg) (Reference)	Bearing No.	
		d	D	2B	r _{min}	r _{1 min}			NSE	NKE	D _s	d _s			
7000W1YDFNSE9	7000W1YDFNKE9	10	26	18	0.3	0.15	7.80	4.65	20,000	30,000	22.6	14.0	0.022	7000W1YDFNSE9	7000W1YDFNKE9
7001W1YDFNSE9	7001W1YDFNKE9	12	28	18	0.3	0.15	8.40	5.40	17,000	27,000	25.3	16.5	0.024	7001W1YDFNSE9	7001W1YDFNKE9
7002W1YDFNSE9	7002W1YDFNKE9	15	32	21	0.3	0.15	9.35	6.80	14,000	23,000	28.5	19.3	0.035	7002W1YDFNSE9	7002W1YDFNKE9
7003W1YDFNSE9	7003W1YDFNKE9	17	35	23	0.3	0.15	9.75	7.60	13,000	20,000	30.8	21.5	0.045	7003W1YDFNSE9	7003W1YDFNKE9
7004W1YDFNSE9	7004W1YDFNKE9	20	42	27	0.6	0.30	15.9	12.1	11,000	17,000	37.3	25.4	0.079	7004W1YDFNSE9	7004W1YDFNKE9
7005W1YDFNSE9	7005W1YDFNKE9	25	47	27	0.6	0.30	17.3	14.9	9,000	15,000	42.3	30.5	0.091	7005W1YDFNSE9	7005W1YDFNKE9
7200W1YDFNSE9	7200W1YDFNKE9	10	30	21	0.6	0.30	10.4	6.25	17,000	24,000	25.3	16.5	0.034	7200W1YDFNSE9	7200W1YDFNKE9
7201W1YDFNSE9	7201W1YDFNKE9	12	32	23	0.6	0.30	11.7	7.30	16,000	22,000	27.8	17.4	0.040	7201W1YDFNSE9	7201W1YDFNKE9
7202W1YDFNSE9	7202W1YDFNKE9	15	35	25	0.6	0.30	12.5	8.60	14,000	23,000	31.0	20.5	0.048	7202W1YDFNSE9	7202W1YDFNKE9
7203W1YDFNSE9	7203W1YDFNKE9	17	40	27	0.6	0.30	15.8	11.0	13,000	20,000	35.3	23.4	0.070	7203W1YDFNSE9	7203W1YDFNKE9
7204W1YDFNSE9	7204W1YDFNKE9	20	47	32	1.0	0.60	21.1	15.3	10,000	14,000	41.5	27.5	0.110	7204W1YDFNSE9	7204W1YDFNKE9
7205W1YDFNSE9	7205W1YDFNKE9	25	52	34	1.0	0.60	23.6	18.9	8,500	12,000	46.5	32.6	0.135	7205W1YDFNSE9	7205W1YDFNKE9

Dimension Tables

Types and Designs

7900/7000/7200

BNH

TAB/TBH

NN3000/NNU4900

XRN/XRG

TAB/TAU/TAFX/XYS1/W1

NACHI contributes to the Process of Manufacturing

Cutting Tools

- Carbide drills & Carbide end drills
- HSS drills & HSS end mills
- Taps
- Metal Band Saws
- Broaches
- Hobs
- Shaving Cutters
- Forming Racks

Machine Tools

Integrated gear skiving machine GMS200

Broaching Machines
Precision form Rolling Machines
Power Cells
Various Processing Machines

Robots

Wing Slicer Type Robot

Lightweight Compact Robots

Seven-axis Articulated Robot

Clean Robots

Enhanced system response capabilities

Welding and General Handling Robots
Heavy Duty/payload Handling Robots

Machining

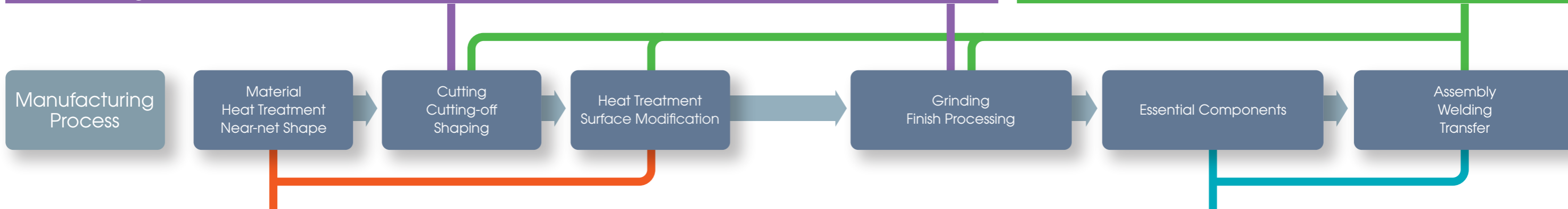

Materials

Special Steels

Fine Multi-Controlled ALLOY
Hardened Rods
Micron Hard

Industrial Furnaces

Vacuum Carburizing Furnace
Vacuum Degreasing Washer
Coating Equipment
Coating Process

Maintenance of Industrial Furnaces Heat Treatment and Coating on Consignment

Components

Bearings

High-Function Bearings for Industrial Machines

High-Function Bearings for Automobiles

Hydraulic Equipment

High-Function Hydraulic Equipment for Construction Machines and Industrial Machines

Automotive Hydraulics

Solenoid Valves for Automobiles
3-way Solenoid Valves
Linear Solenoid Valves
Automotive Hydraulic Units

PZH high-pressure variable piston pump



NACHI-FUJIKOSHI CORP.

www.nachi.com

Head Office Shiodome Sumitomo Bldg.17F 1-9-2 Higashi-Shinbashi, Minato-ku, Tokyo 105-0021 Tel:+81(0)3-5568-5111 Fax:+81(0)3-5568-5206
Bearing Division 1-1-1 Fujikoshi-Honmachi, Toyama 930-8511 Tel:+81(0)76-423-5120 Fax:+81(0)76-493-5231

America & Europe

NACHI AMERICA INC. HEAD QUARTERS

715 Pushville Road, Greenwood, Indiana, 46143, U.S.A.
Tel: +1-317-530-1001 Fax: +1-317-530-1011 <http://www.nachiamerica.com/>

NACHI CANADA INC.

89 Courtnland Ave., Unit No.2, Concord, Ontario, L4K 3T4, CANADA
Tel: +1-905-660-0088 Fax: +1-905-660-1146 <http://www.nachicanada.com/>

NACHI MEXICANA, S.A. DE C.V.

Calle T equisquitapan 2, Aerotech Industrial Park, Localidad Galeras, Municipio de Colon, Queretaro, C.P. 76295, MEXICO
Tel: +52-442-153-2424 Fax: +52-442-153-2435 <http://www.nachi.com.mx/>

NACHI BRASIL LTDA.

Avenida Joao XXIII, No.2330, Jardim São Pedro, Mogi das Cruzes, SP, CEP 08830-000, BRASIL
Tel: +55-11-4793-8800 Fax: +55-11-4793-8870 <http://www.nachi.com.br/>

NACHI EUROPE GmbH

Bischofstrasse 99, 47809, Krefeld, GERMANY
Tel: +49(0)2151-65046-0 Fax: +49(0)2151-65046-90 <http://www.nachi.de/>

SOUTH GERMANY OFFICE

Pleidelshheimer Str. 47, 74321 Bietigheim-Bissingen GERMANY
Tel: +49(0)7142-77418-0 Fax: +49(0)7142-77418-20

CZECH BRANCH

Obchodni 132, Cestice 251 01, CZECH REPUBLIC
Tel: +420(0)255-734-000 Fax: +420(0)255-734-001

U.K. BRANCH

Unit 3, 92, Kettles Wood Drive, Woodgate Business Park Birmingham B32 3DB, U.K.
Tel: +44(0)121-423-5000 Fax: +44(0)121-421-7520

TURKEY BRANCH

Ataturk Mah. Mustafa Kemal Cad. No:10/1A. 34758 Atasehir / Istanbul, TURKEY
Tel: +90(0)216-688-4457 Fax: +90(0)216-688-4458

Asia & Oceania

NACHI TECHNOLOGY (THAILAND) CO., LTD.

5/5 M, 2, Rojana Industrial Park Nongbua, Ban Khai, Rayong, 21120, THAILAND
Tel: +66-38-961-682 Fax: +66-38-961-683 <http://www.nachi.co.th/>

NACHI SINGAPORE PTE. LTD.

No.2 Joo Koon Way, Jurong Town, Singapore 628943, SINGAPORE
Tel: +65-65587393 Fax: +65-65587371 <http://www.nachinip.com.sg/>

VIETNAM REPRESENTATIVE OFFICE, HANOI

1502A, 15FL, IPH building, 241 Xuan Thuy st., Cau Giay dist, Ha Noi, VIETNAM
Tel: +84-24-3767-8605 Fax: +84-24-3767-8604

VIETNAM REPRESENTATIVE OFFICE, HO CHI MINH

4FL, Yocco Bld., 41 Nguyen Thi Minh Khai St., Dist.1, Ho Chi Minh, VIETNAM
Tel: +84-28-3822-3919 Fax: +84-28-3822-3918

NACHI VIETNAM CO., LTD.

1502B, 15FL, IPH building, 241 Xuan Thuy st., Cau Giay dist, Ha Noi, VIETNAM
Tel: +84-24-3767-8605 Fax: +84-24-3767-8604

NACHI PILIPINAS INDUSTRIES, INC.

1st Avenue, Manalac Compound, Sta. Maria Industrial Estate, Bagumbayan, Taguig, Metro Manila, PHILIPPINES
Tel: +63(0)2-838-3620 Fax: +63(0)2-838-3623

FUJIKOSHI-NACHI (MALAYSIA) SDN. BHD.

No.17, Jalan USJ 21/3, 47630 UEP Subang Jaya, Selangor Darul Ehsan, MALAYSIA
Tel: +60(0)3-80247900 Fax: +60(0)3-80235884

PT.NACHI INDONESIA

TEMPO SCAN TOWER, 31FL JL.H.R. Rasuna Said Kav. 3-4, Kuninggan, Jakarta Selatan DKI Jakarta -12950, INDONESIA
Tel: +62-21-527-2841 Fax: +62-21-527-3029 <http://www.nachi.co.id/>

NACHI TECHNOLOGY INDIA PVT. LTD. GURGAON HEAD OFFICE

3rd Floor, Plot No.6, Siddhartha House, Sector 44, Gurgaon 122003, Haryana, INDIA
Tel: +91(0)12-4450-2900 Fax: +91(0)12-4450-2910

NEEMRANA FACTORY

Plot No. Sp-86, Nic(M)Neemrana, Riico Industrial Area, Alwar 301705, Rajasthan, INDIA
Tel: +91(0)14-9467-1300 Fax: +91(0)14-9467-1310

BANGALORE OFFICE

F-11, Asha Chamber, No.2, Venkata Swamy Raju Road, Kumara Park West, Bangalore-560020, INDIA
Tel: +91(0)80-3920-8701, 02 & 03, Fax: +91(0)80-3920-8700

NACHI (AUSTRALIA) PTY. LTD.

Unit 1, 23-29 South Street, Rydalmere, N.S.W. 2116, AUSTRALIA
Tel: +61(0)2-9898-1511 Fax: +61(0)2-9898-1678 <http://www.nachi.com.au/>

NACHI (SHANGHAI) CO., LTD.

5F, Building A, National Center for Exhibition and Convention, 1998 Zhuguang Road, Qingpu District, Shanghai, 201702, CHINA
Tel: +86(0)21-6915-2200 Fax: +86(0)21-6915-5427 <http://www.nachi-china.com.cn/>

NACHI TAIWAN CO., LTD.

2F, No 23, Lane 15, Sec. 6, Minquan E. Rd., Neihu Dist., Taipei City, TAIWAN
Tel: +886(0)2-2792-1895 Fax: +886(0)2-2792-1872

NACHI C.Y. CORP.

No.109, Kao Yuan North Rd, Lung-Tan Dist, Taoyuan City, TAIWAN
Tel: +886(0)3-471-7651 Fax: +886(0)3-471-8402

NACHI-FUJIKOSHI CORP. KOREA REPRESENTATIVE OFFICE

By Center 2F, 56, Seoungsulho, Seongdong-Gu, Seoul, 04782, KOREA
Tel: +82(0)2-469-2254 Fax: +82(0)2-469-2264



The appearance and specifications may be changed without prior notice if required to improve performance. Every care has been taken to ensure the accuracy of the information contained in this catalog but no liability can be accepted for any errors or omissions.

ired to improve performance.
in

CATALOG NO.	B1031E-6
--------------------	-----------------

2018.07.Z-ABE-ABE